

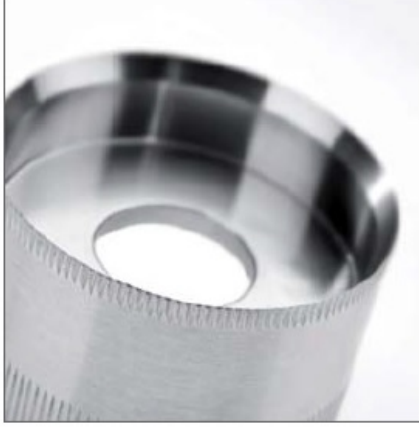



Plastische Chirurgie
Plastic Surgery
Cirugía Plástica
Chirurgia Plastica



MT- Braun Instrumente





MT- Braun Instrumente

Marktplatz 21, 78549

Spaichingen (Tuttlingen)

Charrière (Ch) French (F)	Durchmesser in mm	Inches
1	0,33	0,013
2	0,67	0,025
3	1,00	0,039
4	1,33	0,051
5	1,67	0,065
6	2,00	0,0787
7	2,33	0,092
8	2,67	0,105
9	3,00	0,1181
10	3,33	0,131
11	3,67	0,144
12	4,00	0,1575
13	4,33	0,170
14	4,67	0,184
15	5,00	0,1968
16	5,33	0,210
17	5,67	0,223
18	6,00	0,2362
19	6,33	0,249
20	6,67	0,263
21	7,00	0,2756
22	7,33	0,288
23	7,67	0,302
24	8,00	0,3150
25	8,33	0,328
26	8,67	0,341
27	9,00	0,3543
28	9,33	0,367
29	9,67	0,380
30	10,00	0,3973
31	10,33	0,407
32	10,67	0,420
34	11,33	0,446
36	12,00	0,4724
38	12,67	0,494
40	13,33	0,5199
45	15,00	0,5905

Gauge (G)	Durchmesser in mm	Inches
35	0,13	0,005
34	0,18	0,007
33	0,20	0,008
32	0,23	0,009
31	0,25	0,010
30	0,30	0,012
29	0,33	0,013
28	0,36	0,014
27	0,41	0,016
26	0,46	0,018
25	0,51	0,020
	0,53	0,021
24	0,56	0,022
23	0,64	0,025
22	0,71	0,028
21	0,81	0,032
20	0,89	0,035
	0,97	0,038
19	1,07	0,042
18	1,27	0,050
17	1,50	0,059
16	1,65	0,065
15	1,83	0,072
14	2,11	0,083
13	2,41	0,095
12	2,77	0,109
11	3,05	0,120
10	3,40	0,134
9	3,76	0,148
8	4,19	0,165
7	4,57	0,180
6	5,16	0,203

1 OZ	0,028 ml
5 OZ	0,140 ml
16 OZ	0,450 ml

35 OZ	1,0 l
128 OZ	3,7 l

GARANTIE / WARRANTY / GARANTIA / GARANZIA

GARANTIE

Wir gewähren auf alle MT-Braun Instrumente 5 Jahre Garantie. Voraussetzung ist der sach- und fachgerechte Einsatz der Instrumente. Von der Garantie sind Verschleißerscheinungen ausgeschlossen.

WARRANTY

Our MT-Braun Instrumente products are free from manufacturing defects in material and workmanship. We therefore give on all instruments a guarantee of five years provided that the instruments are maintained and cleaned properly and used normally for their intended purpose.

GARANTIA

Estamos convencidos de nuestra calidad y concedemos a todos los instrumentos de MT-Braun Instrumente 5 años de garantía contra cualquier defecto de fabricación, siempre y cuando se usen adecuadamente. De la garantía excluimos la manifestación de desgaste.

GARANZIA

Siamo convinti della nostra qualità e concediamo cinque anni di garanzia sulla funzione dei tutti gli strumenti MT-Braun Instrumente sotto la presupposizione che l'utilizzo è da esperto. Escluso della garanzia sono tracce di consumo.

Arbeitsanweisung Aufbereitung (Reinigung) und Sterilisation von resterilisierbaren chirurgischen Instrumenten

DIN EN ISO 17664:2004 (D)

Hersteller:
MT-BRAUN INSTRUMENTE Instrumente ,
Marktplatz 21D-78532 Tuttingen

Alle von Mt-Braun Instrumente gelieferten wieder verwendbaren Instrumente wurden ausschließlich für den chirurgischen Gebrauch konstruiert und dürfen zu keinen anderen Zwecken benutzt werden. Unsachgemäße Handhabung und sorglose Pflege sowie zweckentfremdeter Gebrauch können zu vorzeitigem Verschleiß der Instrumente führen. Die Produkte sind bei der Auslieferung nicht sterilisiert.

Reinigungsvorbereitung

Fabrikneue Instrumente müssen vor der ersten Anwendung den gesamten Aufbereitungsprozess durchlaufen. Instrumente unmittelbar nach Anlieferung aus den Folienverpackungen entnehmen und in trockenen Räumen bei gleichbleibender Raumtemperatur luftoffen lagern, um Kondensationsbildung zu vermeiden.

Die Instrumente keinen Sonnenlichteinstrahlungen oder Dämpfen durch Chemikalien (Säuren oder scharfe Reinigern) aussetzen.

Vor der ersten Sterilisation alle Schutzkappen und Folien vollständig entfernen und anschließend reinigen.

Gebrauchte Instrumente unmittelbar nach Beendigung des Eingriffs von Blut, Gewebe und Arzneimittel reinigen. Instrumente in eine freigegebene Lösung eines kombinierten Reinigungs- und Desinfektionsmittels, das keine proteinfixierende Wirkung besitzt, einlegen.

Dosierung des Herstellers beachten. Nicht in NaCl Lösung einlegen, ansonsten Gefahr für Loch- bzw. Spannungsriss-Korrosion

Überfüllung von Instrumentensieben und Wasch-Trays vermeiden.

Gelenkinstrumente vor dem Aufbereiten öffnen. Zerlegbare Instrumente gemäß Bedienungsanleitung (Piktogramm) zur Reinigung zerlegen. Reinigungsgerechtes Zubehör verwenden. Für die manuelle Reinigung nie Metallbürsten oder Metallschwämme verwenden. Spülmaschinen und Ultraschallanlagen nicht überladen. Spül- oder Schallschatten vermeiden. Dosierung, Einwirkzeit und Einwirktemperatur bei der Desinfektion und Reinigung unbedingt einhalten. Nach der Reinigung sorgfältig spülen. Möglichst vollentsalztes (demineralisiertes) Wasser verwenden.

Nach dem Spülen ausreichend trocknen. Abgenutzte, korrodierte, deformierte, poröse oder anderweitig beschädigte Instrumente austrieren.

Aus hygienischen Gründen müssen Instrumente, die zur Reparatur eingesandt werden komplett aufbereitet werden.

Gelenkinstrumente nach jeder Aufbereitung mit einem Pflegemittel auf Basis von Paraffinöl behandeln (gilt nicht für flexible Endoskope und Zubehör).

Funktionsprüfung in zusammengebautem Zustand durchführen.

Instrumente mit Rastensperre vor der Sterilisation nur im ersten Zahn schließen.

Als Sterilisationsverfahren empfehlen wir die Dampfsterilisation (üblicherweise mit Sattedampf bei 134° C)

Sterilisation ist kein Ersatz für Sauberkeit!

Die Broschüre "Instrumenten-Aufbereitung richtig gemacht" des Arbeitskreis Instrumenten-Aufbereitung dient als Anhalt.

Mt-Braun Instrumente
Instrumente 78532
Spaichingen (Tuttingen)

IMPORTANT INFORMATION CONCERNING PREPARING AND STERILIZING SURGICAL INSTRUMENTS

Dear Sirs,
please read the following instructions very carefully before using the instruments.

1. INITIAL USE

All instruments which are being used for the first time must be thoroughly cleaned, rinsed and then sterilized before using.

2. TREATING INSTRUMENTS AFTER USAGE

- a.) The instruments might be immediately thoroughly cleaned and disinfected. Please follow the manufacturer's instructions when using cleaning agents and disinfectants.
- b.) Instruments which may be dismantled must be cleaned and disinfected after being taken apart.
- c.) Cleaning may be carried out either manually or with a machine. Care should be taken that only cleaning agents and disinfectants are used, which are changed daily.
- d.) Following chemical disinfection and manual cleaning, all instruments must always be thoroughly rinsed under running water.
- e.) The temperature of water used in a machine for cleaning should not exceed 45°C.
- f.) Whether cleaning is carried out manually or by machine, we especially ask you to ensure that the correct dosage for cleaning solutions or the correct combination of disinfectant and cleaning solution, is employed. Similar importance should be applied to the length of time the agents require to perform properly and to the temperature set.
- g.) Hinged instruments should be opened before cleaning.
- h.) Please ensure that the perforated instrument trays, when loaded, do not exceed 10 kg in weight.
- i.) Please take care that when instruments are being cleaned they are arranged proper in a manne that fluids can circulate freely.
- j.) Deposits remaining after the cleaning process must be completely removed in the first rinse which now follows. The optimum temperature for final rinsing has proved to be between 70° and 90° C. Please use only purified water in this final cleaning stage.
- k.) The instruments must be carefully dried after cleaning and rinsing is completed.
- l.) Moving parts and the cutting edges of shears and scissors must be treated with preservatives which are both suitable and physiologically safe.

3. TESTING FOR CORRECT FUNCTIONING

- a.) Instruments must be carefully and thoroughly checked before every occasion that they are used.

- b.) After each time they are cleaned, the instruments must be macroscopically clean, i.e., visibly free from proteinbased residues and other soiling.
- c.) Care should be taken so that cracks, breakages and corrosion are noticed.
- d.) Instruments with flecks should be separated and taken out for special treatment.
- e.) All moving parts as well as working tips and blades should be checked with special care.
- f.) Checking should be carried out according to the extent to which the instruments will be used.
- g.) Instruments which are in any way defective or damaged should be immediately sorted out from the others.

4. STERILIZATION

- a.) All stainless steel surgical instruments supplied by us may be sterilized in an autoclave.
- b.) Please follow the manufacturer's operating instructions when using autoclave. All machines used must comply with all current quality and other standards.
- c.) Instruments are being sterilized/ autoclaved at a temperature of 134°C.
- d.) Sterilization packing material must comply with all current standards.
- e.) Instruments with ratchets or self-retaining mechanisms should be sterilized opened or in the first ratchet position.
- f.) Please ensure that perforated instrument trays, when loaded do not exceed 10 kg in weight.

5. IN GENERAL

- a.) All surgical instruments supplied by us have been thoroughly inspected before dispatch and leave our factory in perfect condition. Damage which can arise as a result of transporting, cleaning, preserving, sterilizing or storing, must be prevented.
- b.) Please handle surgical instruments always with the utmost care.
- c.) Instruments must be stored in a clean and dry place.
- d.) If you have any queries or problems please contact us at any time:

We should like to point out that, if the above-mentioned directions are not followed or the instruments supplied by us are not properly used, all guarantee claims become void and any consequences must be borne by yourselves.

SUGERENCIAS PARA LA LIMPIEZA, ESTERILIZACIÓN Y MANTENIMIENTO DE INSTRUMENTOS QUIRÚRGICOS

ENJUAGADO

Tras el uso enjuagar enseguida los instrumentos bajo un chorro de agua caliente (no hirviendo). El enjuagado debe servir para quitar los residuos de sangre, mucosas y tejidos.

LIMPIEZA

Si la limpieza no se efectúa inmediatamente después del enjuagado, los instrumentos tienen que sumergirse en una solución de agua y detergente con PH neutro (7)

Para los instrumentos muy delicados (algunos tipos de porta agujas o tijeras se aconseja una limpieza manual: ver punto "C").

a.- Limpieza en la pila de ultrasonido

Los instrumentos tienen que estar en la pila el tiempo necesario recomendado por el fabricante para efectuar el ciclo del lavado, generalmente de 5 a 10 minutos.

Los instrumentos con bisagras o juntas (articulaciones) tienen que sumergirse en la pileta en posición abierta.

Asegurarse de que las hojas afiladas de las tijeras, bisturíes para gingivectomía, curetas, etc. no estén en contacto con otros instrumentos.

Todos los instrumentos deben estar completamente sumergidos en la solución de lavado.

No poner instrumentos de diferentes metales (acero inoxidable, instrumentos cromados, latón, etc.) en el mismo ciclo de lavado.

Cambiar a menudo la solución para el lavado, como mínimo todas las veces que lo recomienda el fabricante de la pileta de ultrasonidos.

Enjuagar concienzudamente los instrumentos con agua corriente tras lavado con ultrasonidos para quitar los residuos de la solución de lavado.

b.- Limpieza con lavadora

Seguir las indicaciones del fabricante. Asegurarse de que los instrumentos hayan sido lubricados tras el último ciclo de lavado y antes del ciclo de esterilización.

c.- Limpieza manual

La mayor parte de los fabricantes de instrumentos indican el lavado con los ultrasonidos como el modo mejor y más eficaz para limpiar los instrumentos quirúrgicos, especialmente los que tienen bisagras, cierres y en general articulaciones. Si la limpieza con los ultrasonidos no es posible, se aconseja usar el método siguiente:

- Usar cepillos rígidos de plástico, nylon, etc.
- Cepillar concienzudamente los instrumentos más delicados y, si es posible, enjuagar, limpiar y esterilizar estos instrumentos separadamente.
- Verificar que toda la superficie de estos instrumentos esté limpia.
- Tras haber cepillado los instrumentos, enjuagarlos bajo el chorro de agua corriente.
- Durante el enjuagado abrir y cerrar las tijeras, las pinzas hemostáticas, los porta agujas y los demás instrumentos con bisagras o juntas y asegurarse de que las partes internas de las bisagras estén perfectamente enjuagadas como la superficie externa del instrumento.

SECADO, LUBRIFICACIÓN E INSPECCIÓN

Tras las operaciones de limpieza y de enjuagado, los instrumentos quirúrgicos tienen que ser secados perfectamente.

Todos los instrumentos con juntas o bisagras (acción "metal contra metal") como tijeras, pinzas hemostáticas, porta agujas, fórceps de extracción, etc., tienen que ser lubricados. Se aconsejan lubricantes específicos para el instrumental quirúrgico. No usar aceites o lubricantes industriales.

A este punto es buena norma inspeccionar el estado de cada instrumento y verificar el funcionamiento según el uso específico. Controlar y asegurarse de que:

- Las hojas de las tijeras estén lisas de arriba abajo y de que, una vez cerradas, no hagan juego. Probar las tijeras cortando gasa muy fina. Tres cuartas parte de la hoja tienen que cortar la gasa sin retenerla.

- Las puntas de las pinzas estén al mismo nivel.
- Las pinzas hemostáticas y los porta agujas no dejen pasar la luz entre las puntas cuando estén cerradas, se abran y cierren fácilmente y que las bisagras no estén demasiado flojas.
- Controlar el desgaste de la porta agujas sobre la superficie interna de las puntas.
- Las cánulas metálicas de aspiración estén bien limpias en su interior.
- Los instrumentos cortantes y los bisturíes tengan las hojas bien afiladas y no estropeadas.

ESTERILIZACIÓN EN AUTOCLAVE

Tras haber enjuagado, limpiado, secado, lubricado e inspeccionado los instrumentos, éstos pueden ser preparados para la esterilización separadamente o en serie.

Instrumentos individuales:

Las bolsas especiales monouso son el ideal para contener los instrumentos. Asegurarse de que las bolsas que contendrán los instrumentos con cierres y articulaciones (pinzas hemostáticas, porta agujas, etc.) sean lo bastante grandes como para contener los citados instrumentos en posición abierta.

Instrumentos en serie:

Poner los instrumentos en los especiales cestos o bandejas de acero inoxidable. Poner los instrumentos más pesados en la parte inferior cuando sean necesarias varias bandejas.

No cerrar nunca los instrumentos durante el ciclo en autoclave. Un instrumento cerrado no estará nunca bien esterilizado, ya que el vapor no puede penetrar en la parte de cierre a contacto "metal contra metal". En el instrumento podría además romperse en la parte de la bisagra a causa de la expansión del metal debida al calor durante el ciclo del autoclave.

No cargar demasiado la cámara del autoclave ya que algunos instrumentos podrían formar "zonas de sombra" sobre otros en los que el vapor no penetraría.

ATENCIÓN

Al final del ciclo de esterilización - antes del ciclo de secado- abrir ligeramente la portezuela del autoclave y proceder con el ciclo desecado según las instrucciones del fabricante. Si la portezuela del autoclave se abriese completamente antes del ciclo de secado, el aire frío de la habitación entraría en la cámara del autoclave causando la formación de condensación sobre los instrumentos y de consecuencia aparecerían las manchas de agua que vemos a menudo en los mismos.

ESTERILIZACIÓN EN FRÍO:

La mayor parte de las soluciones para la esterilización en frío esterilizan los instrumentos completamente tras 10 horas de inmersión. Esta acción química prolongada puede ser más perjudicial para los instrumentos que el ciclo normal de 20 minutos en autoclave.

Si los instrumentos tienen necesidad de ser simplemente "desinfectados", el proceso en frío es adecuado, ya que la desinfección tiene lugar en 10 minutos solamente.

Recuerde bien la diferencia entre:

ESTÉRIL - término absoluto (ningún organismo logra sobrevivir) y

DESINFECTADO - perfectamente limpio.

Usen siempre la técnica más adecuada de esterilización/limpieza de los instrumentos según el uso que se haga posteriormente de ellos.

Recuerden que la esterilización de los instrumentos no sustituye la limpieza de los mismos.

Recomendamos no volver a usar ni esterilizar los artículos de un solo uso.

Si se tratan en el modo correcto los instrumentos contruidos con las modernas aleaciones inoxidables pueden durar muchos años.

INDICAZIONI PER LA CURA, PULITURA E LA STERILIZZAZIONE DELLO STRUMENTARIO CHIRURGICO RISTERILIZZABILE

Misure preventive anticorrosione

- 1) Raggruppare accuratamente gli strumenti correttamente confezionati e sterilizzati prima dell'operazione; selezionarli secondo l'intervento. Verificare sempre che la confezione esterna sia integra e che lo strumento stesso non sia danneggiato.
- 2) Assicurarli tramite l'indicatore di sterilizzazione collocato all'interno del vaglio che il contenuto sia stato sterilizzato.
- 3) Disporre gli strumenti seguendo l'ordine di utilizzo durante l'operazione; lasciare gli strumenti non necessari nel vaglio; predisporre gli strumenti solo immediatamente prima dell'operazione.
- 4) Nel corso dell'operazione rimuovere dagli strumenti sangue ed altri materiali biologici; dopo l'uso, riporre gli strumenti nel corretto alloggiamento.
- 5) Risciacquare opportunamente gli strumenti cavi, al fine di evitare l'adesione di sangue e polvere d'osso.
- 6) Per la pulitura degli strumenti utilizzare una soluzione lattata o una soluzione salina, ma non immergerli nelle suddette soluzioni.
- 7) Iniziare l'operazione di pulitura subito dopo l'intervento. Strumenti utilizzati su pazienti con possibili infezioni: smaltire in modo analogo, eliminando sangue, polvere d'osso parti di tessuto in eccesso.
- 8) Pulire gli strumenti in un luogo previsto nell'ambito della sala operatoria.

Nel caso in cui gli strumenti vadano collocati direttamente nella centrale di sterilizzazione, è necessario dapprima coprirli, per evitare il rischio di contaminazione ai danni del personale o dell'ambiente circostante.

Disinfezione

Durante l'uso di disinfettanti chimici è necessario osservare scrupolosamente le indicazioni del produttore; utilizzare le soluzioni sempre previa diluizione. Nella fase termica di disinfezione con acqua bollente assicurarsi che l'acqua sia priva di corpi estranei.

Pulitura

Indipendentemente dal metodo utilizzato per la pulitura (meccanico o manuale) si raccomanda di verificare attentamente quale detergente vada utilizzato con ciascun metodo. Valori pH consigliati: tra 7,0 e 8,5.

1) Pulitura meccanica

Osservare scrupolosamente le istruzioni d'uso fornite dal produttore della macchina pulitrice. Predisporre gli

strumenti per la pulitura meccanica. Tutti gli strumenti appuntiti e delicati dovrebbero essere puliti manualmente.

Non sovraccaricare i vagli, mettere gli strumenti pesanti sul fondo del vaglio. Se necessario, immergere e risciacquare gli strumenti molto sporchi (strumenti cavi), prima di collocarli nella lavatrice.

2) Pulitura ad ultrasuoni

(fa parte dei metodi di pulitura meccanica)

Prima di inserire uno strumento nel bagno ad ultrasuoni, rimuovere i materiali organici in eccesso. I bagni ad ultrasuoni sono consigliati per le filettatrici o gli strumenti con solchi profondi. L'ultrasuono deve essere seguito da un programma di risciacquo normale.

3) Pulitura manuale

Richiede diverse spazzole in nylon, una canna da soffio ed un ugello da soffio/ un dispositivo ad aria compressa pulito, detergenti e solventi come per la pulitura meccanica.

Per gli additivi di pulitura osservare le indicazioni fornite dal produttore.

Per la pulitura degli strumenti dotati di cannula, passare più volte lo spazzolino di nylon attraverso la cannula eseguendo movimenti rotatori (non utilizzare spazzole in lana d'acciaio/metallo) fino alla completa rimozione dei residui eliminabili con questo metodo.

Soffiare poi con aria compressa nella cannula.

4) Asciugatura

Ogni strumento deve essere asciugato completamente sia internamente che esternamente per evitare la formazione di ruggine o malfunzionamenti.

Indicazioni per la sterilizzazione della strumentazione

Pulire immediatamente ed asciugare bene gli strumenti usati, non utilizzare detergenti e disinfettanti con additivi fortemente acidi o alcalini (ad es. soda, soda caustica o acidi)!

Sterilizzare la strumentazione solo a vapore A 134°!

Prima della sterilizzazione, assicurarsi che gli strumenti siano perfettamente funzionanti ed integri. La sterilizzazione non sostituisce la pulitura.

MT- Braun Instrumente

Markierungs- und Messinstrumente
Marking and Measuring Instruments
Instrumentos para marcar y medir
Strumenti per marcare e misurare



Winkelmesser
Goniometer
Goniómetro
Goniometro

MOELTGEN
05312-01
24 cm, 9 $\frac{1}{2}$ "

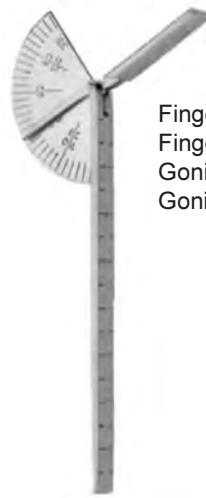

Finger-Goniometer
Finger goniometer
Goniómetro para dedos
Goniometro per le dita

05314-01
13 cm, 5 $\frac{1}{8}$ "



05340-10	10 cm	4"
05340-15	15 cm	6"
05340-20	20 cm	8"
05340-30	30 cm	11 $\frac{3}{4}$ "
05340-50	50 cm	19 $\frac{3}{4}$ "

Markierungsinstrumente
Marking Instruments
Instrumentos para marcar
Strumenti per marcare

Facelift-Markierer
Facelift marker
Marcador para facelift
Marcatore per facelift



PITANGUY
05370-16
16 cm, 6¹/₄"



D'ASSUMPACO
05380-30
30 cm, 11³/₄"



LOCKWOOD
05390-30
32,5 cm, 12³/₄"

MT- Braun Instrumente

Markierungs- und Messinstrumente
Marking and Measuring Instruments
Instrumentos para marcar y medir
Strumenti per marcare e misurare



McKISSOCK

05400-38 38 mm, 1 1/2"
05400-42 42 mm, 1 2/3"
05400-45 45 mm, 1 3/4"



FREEMAN

05500-38 38 mm, 1 1/2"
05500-42 42 mm, 1 2/3"
05500-44 44 mm, 1 3/4"



0-20 mm

CASTROVIEJO

45583-07 7 cm, 2 3/4"
45583-18 18 cm, 7"



COLLIER

75193-30
30 cm, 11 3/4"

Dermatome
Dermatome
Dermàtomo
Dermatomo



SCHINK
09490-00
30 cm, 11³/₄"

compl.
mit/with/con
09490-01 (1) Stk./pcs
09490-02 (2) Stk./pcs



09490-01

Ersatzklinge
Spare blade
Hoja de repuesto
Lama di ricambio per dermatomo

5 cm
2"



10 cm
4"

8 cm
3¹/₈"

4 cm
1¹/₂"

09490-02

Spannplatte
Skin straightening plate
Placa para extender la piel
Placca per stendipelle

MT- Braun Instrumente

Dermatome
Dermatome
Dermátomo
Dermatomo



HUMBY
09495-31
31 cm, 12¹/₄"



SILVER
09498-00
19 cm, 7¹/₂"



WATSON
09499-00
30 cm, 11³/₄"

Ersatzklingen, unsteril / Spare blade, non sterile
Hoja de repuesto, no esteril / Lama di ricambio, non sterile

09496-31

09296-00

09499-01

Skalpellgriffe
Scalpel Handles
Mangos de bisturíes
Manici per lama bisturi

passend zu den Klängen
for blades
para las hojas
per lama bisturi

(A) No. 10, 11, 12, 13, 14, 15, 16, 17, 18, 19



09103-00
Fig. 3

(A)



09103-01
Fig. 3 grad

(A)



09103-02
Fig. 3 L

(A)



09103-03
Fig. 3 L

(A)

MT- Braun Instrumente

Skalpellgriffe
Scapel Handles
Mangos de bisturios
Manici per lama bisturi

passend zu den Klängen
for blades
para las hojas
per lama bisturi

(A) No. 10, 11, 12, 13, 14, 15, 16, 17, 18, 19

(B) No. 20, 21, 22, 23, 24, 25



09104-00
Fig. 4

(B)



09104-02
Fig. 4 L

(B)



09105-02
Fig. 4 L

(B)



09106-01
Fig. 3

(A)

Skalpellgriffe
Scalpel Handles
Mangos de bisturíes
Manici per lama bisturi

passend zu den Klängen
for blades
para las hojas
per lama bisturi

(A) No. 10, 11, 12, 13, 14, 15, 16, 17, 18, 19

(B) No. 20, 21, 22, 23, 24, 25



09107-00
Fig. 7

(A)



09107-01
Fig. 7K

(A)



09108-00
Fig. 8

(B)

MT- Braun Instrumente

Mini-Skalpellgriffe/Skalpellklingen
Scalpel Handles
Mangos de bisturios
Manici per lama bisturi/lame per bisturi



09161-00 09162-00 09165-00 09167-00

Packung mit 10 Stück
box of 10
en cajas de 10 unidades
confezione di 10 pezzi

09109-10 10,0 cm, 4"
09109-13 13,0 cm, 5 1/8"
09109-15 15,5 cm, 6"

Skalpellklingen
 Scalpel Blades, Sterile
 Hojas de bisturí, estéril
 Lame per bisturi, sterili



09110-00



09111-00



09112-00



09113-00



09115-00



09116-00



09118-00



09119-00



09120-00



09121-00



09122-00



09123-00



09124-00



09125-00



Packung mit 100 Stück
 box of 100 each
 en cajas de 100 unidades
 confezione di 100 pezzi

Skalpellklingen-Entferner
 Scalpel Blade Remover
 Quita hojas
 Toglilama



09130-00

MT- Braun Instrumente

Skalpelli
Scalpel Handles
Mangos de bisturios
Manici per lama bisturi



LANDOLT
95385-21 21 cm, 8¹/₄"
95385-25 25 cm, 10"

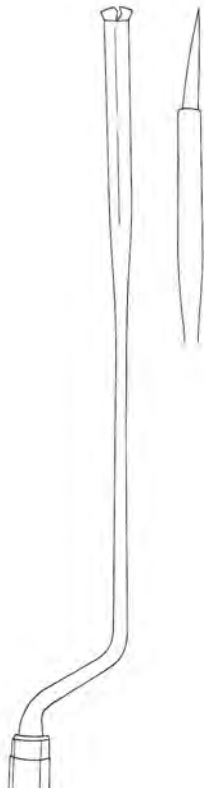

95390-21 21 cm, 8¹/₄"

Präparierscheren
Dissecting Scissors
Tijeras de disección
Forbici per dissezione



MAYO



11160-14	14 cm, 5 $\frac{1}{2}$ "	11161-14
11164-14 TC	14 cm, 5$\frac{1}{2}$"	11165-14 TC
11962-14 SC	14 cm, 5$\frac{1}{2}$"	11963-14 SC
11160-17	17 cm, 6 $\frac{3}{4}$ "	11161-17
11164-17 TC	17 cm, 6$\frac{3}{4}$"	11165-17 TC
11962-17 SC	17 cm, 6$\frac{3}{4}$"	11963-17 SC

MT- Braun Instrumente

Präparierscheren
 Dissecting Scissors
 Tijeras de disección
 Forbici per dissezione



MAYO-STILLE



11170-15	15 cm, 6"	11171-15
11174-15 TC	15 cm, 6"	11175-15 TC
11964-15 SC	15 cm, 6"	11965-15 SC



11170-17	17 cm, 6 ³ / ₄ "	11171-17
11174-17 TC	17 cm, 6³/₄"	11175-17 TC
11964-17 SC	17 cm, 6³/₄"	11965-17 SC

Präparierscheren
Dissecting Scissors
Tijeras de disección
Forbici per dissezione



LEXER



11190-16

16 cm, 6 $\frac{1}{4}$ "

11194-16 TC

16 cm, 6 $\frac{1}{4}$ "



11191-16

11195-16 TC



LEXER-BABY



11202-10

10 cm, 4"

11206-10 TC

10 cm, 4"



11203-10

11207-10 TC

MT- Braun Instrumente

Präparierscheren
 Dissecting Scissors
 Tijeras de disección
 Forbici per dissezione



METZENBAUM



11280-12	12 cm, 4 ³ / ₄ "	11281-12
11284-12 TC	12 cm, 4³/₄"	11285-12 TC
11966-11 SC	12 cm, 4³/₄"	11967-11 SC
11280-15	15 cm, 6"	11281-15
11284-15 TC	15 cm, 6"	11285-15 TC
11970-14 SC	15 cm, 6"	11971-14 SC
11280-18	18 cm, 7"	11281-18
11284-18 TC	18 cm, 7"	11285-18 TC
11970-18 SC	18 cm, 7"	11971-18 SC
11280-20	20 cm, 8"	11281-20
11284-20 TC	20 cm, 8"	11285-20 TC
11970-20 SC	20 cm, 8"	11971-20 SC
11280-23	23 cm, 9"	11281-23
11284-23 TC	23 cm, 9"	11285-23 TC
11970-23 SC	23 cm, 9"	11971-23 SC

Präparierscheren
Dissecting Scissors
Tijeras de disección
Forbici per dissezione



METZENBAUM



11270-15
11270-18

15 cm, 6"
18 cm, 7"



11271-15
11271-18

11274-15 TC	15 cm, 6"	11275-15 TC
11274-18 TC	18 cm, 7"	11275-18 TC



METZENBAUM-FINO



11282-15
11286-15 TC

15 cm, 6"
15 cm, 6"



11283-15
11287-15 TC

11282-18	18 cm, 7"	11283-18
11286-18 TC	18 cm, 7"	11287-18 TC

11282-20	20 cm, 8"	11283-20
11286-20 TC	20 cm, 8"	11287-20 TC

11282-23	23 cm, 9"	11283-23
11286-23 TC	23 cm, 9"	11287-23 TC



MT- Braun Instrumente

Präparierscheren
Dissecting Scissors
Tijeras de disección
Forbici per dissezione



SANVENERO



11302-14

14 cm, 5 1/2"



11303-14



JOSEPH



11304-14

14 cm, 5 1/2"



11305-14

Präparierscheren
 Dissecting Scissors
 Tijeras de disección
 Forbici per dissezione



- | | |
|--------------------|---|
| 11310-12 | 12 cm, 4 ³ / ₄ " |
| 11314-12 TC | 12 cm, 4³/₄" |
| 11995-12 SC | 12 cm, 4³/₄" |
| 11310-15 | 15 cm, 6" |

KILNER (RAGNELL)



- REYNOLDS (JAMESON)
- | | |
|--------------------|------------------|
| 11321-15 | 15 cm, 6" |
| 11993-15 SC | 15 cm, 6" |
| 11321-18 | 18 cm, 7" |

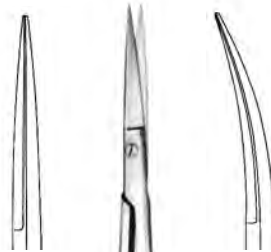

- KELLY
- | | | |
|--------------------|---|--------------------|
| 11540-16 | 16 cm, 6 ¹ / ₄ " | 11541-16 |
| 11542-16 TC | 16 cm, 6¹/₄" | 11543-16 TC |
| 11544-16 SC | 16 cm, 6¹/₄" | 11545-16 SC |

MT- Braun Instrumente

Feine Scheren
 Delicate Scissors
 Tijeras finas
 Forbici delicate



IRIS

11340-09	9 cm, 3 1/2"	11341-09
11340-10	10 cm, 4"	11341-10
11340-11	11 cm, 4 3/8"	11341-11
11344-11 TC	11 cm, 4 3/8"	11345-11 TC
11980-11 SC	11 cm, 4 3/8"	11981-11 SC



BONN

11342-08 8 cm, 3 1/8" 11343-08

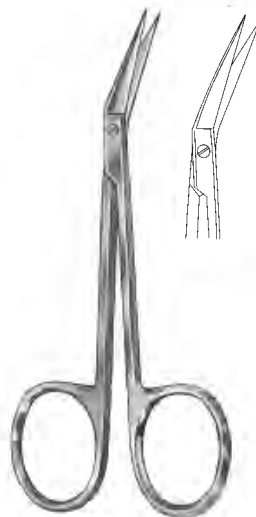

IRIS

11346-11
 11 cm, 4 3/8"

Feine Scheren
Delicate Scissors
Tijeras finas
Forbici delicate



KNAPP
10 cm, 4"



11348-01



11348-02



11348-03



11348-04



11348-05



11348-06

MT- Braun Instrumente

Feine Scheren
Delicate Scissors
Tijeras finas
Forbici delicate



LITTLER
11349-12
12 cm, 4³/₄"



GRAEFE
11350-10
10 cm, 4"



CONVERSE/WILMER
11352-10
10 cm, 4"



COTTLE
11358-11
11 cm, 4³/₈"

Feine Scheren
Delicate Scissors
Tijeras finas
Forbici delicate



GRADLE
11350-09 9,5 cm, 3³/₄" 11351-09



11352-09 9,5 cm, 3³/₄" 11353-09



11354-10 10 cm, 4" 11355-10



11356-10 10 cm, 4" 11357-10

MT- Braun Instrumente

Feine Scheren
 Delicate Scissors
 Tijeras finas
 Forbici delicate



STEVENS
 11 cm, 4³/₈"

spitz
 sharp
 agudo
 acuti



11360-11
11984-11SC



11361-11
11985-11 SC



stumpf
 blunt
 romo
 smussi



11362-11



11363-11

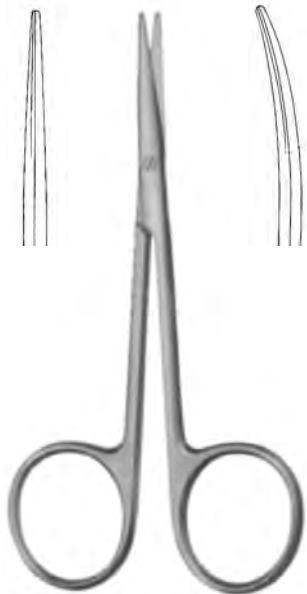
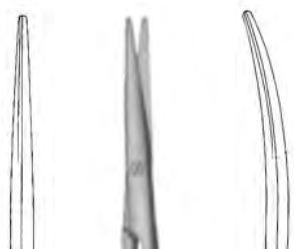

STRABISMUS

11370-11 11 cm, 4³/₈" 11371-11

11374-11TC 11 cm, 4³/₈" 11375-11TC

Feine Scheren
Delicate Scissors
Tijeras finas
Forbici delicate



WAGNER
12 cm, 4³/₄"



11828-12



11826-12



11824-12

11982-12SC



WAGNER
12 cm, 4³/₄"



11823-12



11829-12



11825-12

11983-12 SC

MT- Braun Instrumente

Zahnfleissscheren
Gum Scissors
Tijeras para encias
Forbici gengivali



LA GRANGE
11854-11
11,5 cm, 4 1/2"



CHADWICK
11855-11
11,5 cm, 4 1/2"

Nasenscheren
Nasal Scissors
Tijeras nasales
Forbici nasali



HEYMAN
11401-18 18 cm, 7"



FOMON
11403-15 15 cm, 6"



COTTLE
11405-16 16 cm, 6¹/₄"
11405-16TC 16 cm, 6¹/₄"

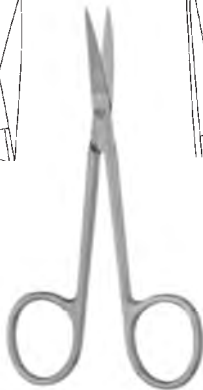
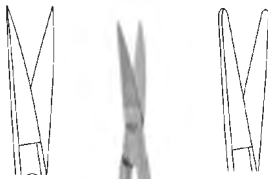

COTTLE-MASING
11406-10 10 cm, 4" 11407-10



FOMON
11617-13 13 cm, 5¹/₈"

MT- Braun Instrumente

Fadenscheren
Stitch Scissors
Tijeras para hilos
Forbici taglia fili



SPENCER
11802-09 9 cm, 3 $\frac{1}{2}$ "
11802-11 11 cm, 4 $\frac{3}{8}$ "



LITTAUER
11804-14
14 cm, 5 $\frac{1}{2}$ "



O'BRIEN
11805-09
9 cm, 3 $\frac{1}{2}$ "

MT- Braun Instrumente

Knorpelscheren/Zahnfleischscheren
Cartilage Scissors/Gum Scissors
Tijeras para cartilago/Tijeras para encías
Forbici per cartilagine/Forbici gengivali



MC INDOE
11614-19
19 cm, 7 1/2"

1 Schneide gezahnt
1 blade toothed
1 hoja dentada
1 taglio dentellato



11820-13 GOLDMAN-FOX 11821-13
13 cm, 5 1/8" 11821-13SC

MT- Braun Instrumente

Face-Lift Scheren
 Face-Lift Scissors
 Face Lift tijeras
 Face Lift forbici



GORNEY

12010-19	19 cm, 7 1/2"	12011-19
12012-19 TC	19 cm, 7 1/2"	12013-19 TC
12014-19 SC	19 cm, 7 1/2"	12015-19 SC



GORNEY-FREEMAN

12061-19	19 cm, 7 1/2"
12061-19 TC	19 cm, 7 1/2"
12061-19 SC	19 cm, 7 1/2"
12061-23	23 cm, 9"
12061-23 TC	23 cm, 9"
12061-23 SC	23 cm, 9"

Face-Lift Scheren
 Face-Lift Scissors
 Face-Lift tijeras
 Face Lift forbici



KAYE

12028-14 TC	14 cm, 5½"	12029-14 TC
12034-14 SC	14 cm, 5½"	12035-14 SC
12030-18 TC	18 cm, 7"	12031-18 TC
12036-18 SC	18 cm, 7"	12037-18 SC
12032-23 TC	23 cm, 9"	12033-23 TC
12038-23 SC	23 cm, 9"	12039-23 SC



PECK-JOSEPH

12044-14	14,5 cm, 5¾"	12045-14
12048-14 SC	14,5 cm, 5¾"	12049-14 SC



BEUSE

12050-14	14 cm, 5½"	12051-14
12050-18	18 cm, 7"	12051-18

—MT- Braun Instrumente

Blepharoplastik Scheren
Blepharoplasty Scissors
Tijeras para blefaroplastia
Forbici per blefaroplastica



GREENBERG-PAR
12201-11 11,5 cm 4½"
12201-11SC 11,5 cm 4½"



KAYE
12206-11 11,5 cm, 4½" 12207-11
12206-11SC 11,5 cm, 4½" **12207-11SC**

Mikro Scheren
 Micro Scissors
 Micro tijeras
 Micro Forbice



10 mm

11 cm
 4³/₈"

12202-11

12203-11

14,5 cm
 5³/₄"

12202-14
12202-14T

12203-14
12203-14T

18 cm
 7"

12202-18
12202-18T

12203-18
12203-18T

21 cm
 8¹/₄"

12202-21
12202-21T

12203-21
12203-21T

23 cm
 9"

12202-23

12203-23

T= Titan, titanium, titanio, titanio

MT- Braun Instrumente

Mikro Scheren
Micro Scissors
Micro tijeras
Micro Forbice



18 cm 7"



25°

12220-25

12220-25T



45°

12220-45

12220-45T



60°

12220-60

12220-60T



90°

12220-90

12220-90T



125°

12220-00





12220-00T

T= Titan, titanium, titanio, titanio

Mikro Scheren
 Micro Scissors
 Micro tijeras
 Micro Forbice

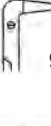

10 mm

	11 cm 4 ³ / ₈ "	14,5 cm 5 ³ / ₄ "	18 cm 7"	21 cm 8 ¹ / ₄ "	23 cm 9"
 25°	12226-11	12226-14	12226-18 12226-18T	12226-21	12226-23
 45°	12227-11	12227-14	12227-18 12227-18T	12227-21	12227-23
 60°	12228-11	12228-14	12228-18 12228-18T	12228-21	12228-23
 90°	12229-11	12229-14	12229-18 12229-18T	12229-21	12229-23
 125°	12230-11	12230-14	12230-18 12230-18T	12230-21	12230-23

T= Titan, titanium, titanio, titanio

MT- Braun Instrumente

Anatomische und chirurgische Pinzetten
 Dressing and Tissue Forceps
 Pinzas de disección sin/con dientes
 Pinze per dissezione, chirurgiche/anatomiche



STANDARD

USA

STILLE

cm

10,5 4 1/4"

13102-10

11,5 4 1/2"

13102-11

12,0 4 3/4"

13104-12

13,0 5 1/8"

13102-13

13104-13

13106-13

14,5 5 3/4"

13102-14

13103-14

13104-14

13106-15

15,0 6"

15,5 6"

13104-15

16,0 6 1/4"

13102-16

18,0 7"

13102-18

13104-18

20,0 8"

13102-20

21,0 8 1/4"

13104-21



schmal
 narrow
 estrecha
 stretta



POTTS-SMITH



POTTS-SMITH
 1x2

cm

11,5 4 1/2"

13110-11

13,0 5 1/8"

13110-13

14,5 5 3/4"

13110-14

13114-14 TC

16,0 6 1/4"

13110-16

13114-16 TC

18,0 7"

13110-18

13112-18

13116-18 TC

13126-18

20,0 8"

13110-20

13114-20 TC

21,0 8 1/4"

13110-25

13114-25 TC

13112-21

13116-21 TC

13126-21

25,0 10"

13110-25









13114-25 TC

13112-25

13116-25 TC

13126-25

Chirurgische Pinzetten
Tissue Forceps
Pinzas de disección con dientes
Pinze per dissezione, chirurgiche

				
	1x2	1x2	1x2	1x2
	STANDARD	USA	STILLE	schmal narrow estrecha stretta
cm				
10,5	4 1/4" 13120-10			
11,5	4 1/2" 13120-11	13122-12		13130-11
12,0	4 3/4" 13120-13	13122-13		13130-13
13,0	5 1/8" 13120-14			13130-14
14,5	5 3/4" 13120-14	13122-14		13130-14
15,0	6" 13120-16		13124-15	
15,5	6" 13120-16	13122-15		
16,0	6 1/4" 13120-16			13130-16
18,0	7" 13120-18	13122-18		13130-18
20,0	8" 13120-20			13130-20
21,0	8 1/4" 13120-21	13122-21		
				
	OEHLER	2x3	3x4	4x5
cm				
11,5	4 1/2" 13140-11	13140-11		
13,0	5 1/8" 13140-13	13140-13	13150-13	13160-13
14,5	5 3/4" 13140-14	13140-14	13150-14	13160-14
16,0	6 1/4" 13132-16 TC	13140-16	13150-16	13160-16
18,0	7" 13132-18 TC	13140-18		
20,0	8" 13132-20 TC	13140-20		

—MT- Braun Instrumente

Anatomische und chirurgische Pinzetten
 Dressing and Tissue Forceps
 Pinzas de disección sin/con dientes
 Pinze per dissezione, chirurgiche/anatomiche



ADSON
 13170-12 12,0 cm, 4 3/4"
 13170-15 15,0 cm, 6"



ADSON
 13170-12F 12 cm, 4 3/4"



ADSON
 13174-12 TC 12,0 cm, 4 3/4"
 13174-15 TC 15,0 cm, 6"



ADSON micro
 13176-12 12,0 cm, 4 3/4"
 13176-15 15,0 cm, 6"



ADSON-DeBAKEY atraumatic
 13177-12
 12,0 cm, 4 3/4"



ADSON
 13178-12
 12,0 cm, 4 3/4"

1x2



ADSON
 13179-12
 12 cm, 4 3/4"

2x3

Chirurgische Pinzetten
Tissue Forceps
Pinzas de disección con dientes
Pinze per dissezione, chirurgiche



1x2

ADSON
13180-12 12,0 cm, 4 3/4"
13180-15 15,0 cm, 6"



1x2

ADSON
13180-12F 12 cm, 4 3/4"



1x2

ADSON
13181-12 TC 12,0 cm, 4 3/4"
13181-15 TC 15,0 cm, 6"



BEASELEY BABCOCK
13182-12 12 cm, 4 3/4"



1x2

ADSON micro
13186-12 12,0 cm, 4 3/4"
13186-15 15,0 cm, 6"



1x2

ADSON
13187-12 12 cm, 4 3/4"

—MT- Braun Instrumente

Chirurgische Pinzetten
Tissue Forceps
Pinzas de disección con dientes
Pinze per dissezione, chirurgiche



7x7

ADSON-BROWN

13188-12 12,0 cm, 4 3/4"

13188-15 15,0 cm, 6"

13189-12 TC 12,0 cm, 4 3/4"



7x7

ADSON-BROWN

13188-12F 12 cm, 4 3/4"



7x7

ADSON-BROWN

13191-12 12 cm, 4 3/4"

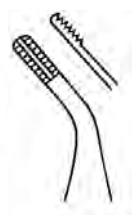

Anatomische und chirurgische Pinzetten
 Dressing and Tissue Forceps
 Pinzas de disección sin/con dientes
 Pinze per dissezione, chirurgiche/anatomiche



1x2

WAUGH

- 13187-18 18 cm, 7"
- 13187-20 20 cm, 8"
- 13187-25 25 cm, 10"
- 13187-30 30 cm, 11 3/4"



9x9

BROWN

- 13189-15 15,0 cm, 6"
- 13189-20 20,0 cm, 8"
- 13189-25 25,0 cm, 10"



GRAEFE

- 13190-10 10,5 cm, 4.1"



13221-17

CUSHING
 13220-17

- 13224-17 TC**
 17,0 cm, 6 3/4"



13223-17

CUSHING
 13222-17

- 13225-17 TC**
 17,0 cm, 6 3/4"

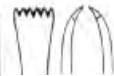

5x6

LERCHE
 13232-15

- 15,0 cm, 6"

—MT- Braun Instrumente

Anatomische und chirurgische Pinzetten
 Dressing and Tissue Forceps
 Pinzas de disección sin/con dientes
 Pinze per dissezione, chirurgiche/anatomiche



1x2

FERRIS-SMITH
 13246-18
 18,0 cm, 7"



2x3

FERRIS-SMITH
 13248-18
 18,0 cm, 7"



DUVAL
 13250-14
 14,5 cm, 5 3/4"



COLLIN-DUVAL
 13252-20
 20,0 cm, 8"



Russ. Mod.
 13256-15 15,0 cm, 6"
 13256-20 20,0 cm, 8"
 13256-25 25,0 cm, 10"



1x2

McINDOE
 13257-15
 15,0 cm, 6"



McINDOE
 13258-15 15,0 cm, 6"
 13259-15 TC 15,0 cm, 6"

Anatomische und chirurgische Pinzetten
 Dressing and Tissue Forceps
 Pinzas de disección sin/con dientes
 Pinze per dissezione, chirurgiche/anatomiche



SEMKEN

- 13260-12 12,5 cm, 5"
- 13260-15 15,5 cm, 6"
- 13261-15 TC 15,5 cm, 6"



1x2

SEMKEN

- 13270-12 12,5 cm, 5"
- 13270-15 15,5 cm, 6"
- 13271-15 TC 15,5 cm, 6"
- 13271-18 TC 18 cm, 7"



1x2

GILLIES

- 13272-15 15,5 cm, 6"
- 13273-15 TC 15,5 cm, 6"



15,5 cm, 6"



13274-06
0,6 mm



13274-08
0,8 mm



13274-10
1,0 mm



GERALD

- 13302-17 17,5 cm, 6.9"
- 13302-23 23,0 cm, 9"
- 13304-17 TC 17,0 cm, 6 3/4"



GERALD

- 13303-17
17,5 cm, 6.9"

MT- Braun Instrumente

Anatomische und chirurgische Pinzetten
 Dressing and Tissue Forceps
 Pinzas de disección sin/con dientes
 Pinze per dissezione, chirurgiche/anatomiche



GERALD
 13305-17
 17,5 cm, 6.9"



GERALD
 13310-17 17,5 cm, 6.9"
 13312-17 TC 17,5 cm, 6.9"



GERALD
 13311-17
 17,5 cm, 6.9"



CUSHING-TAYLOR
 13312-18 TC
 18,5 cm, 7 1/4"



GERALD
 13313-17
 17,5 cm, 6.9"



13314-01



13314-02

TAYLOR
 17 cm, 6 3/4"



13315-01



13315-02

TAYLOR
 17 cm, 6 3/4"

Anatomische und chirurgische Pinzetten
 Dressing and Tissue Forceps
 Pinzas de disección sin/con dientes
 Pinze per dissezione, chirurgiche/anatomiche

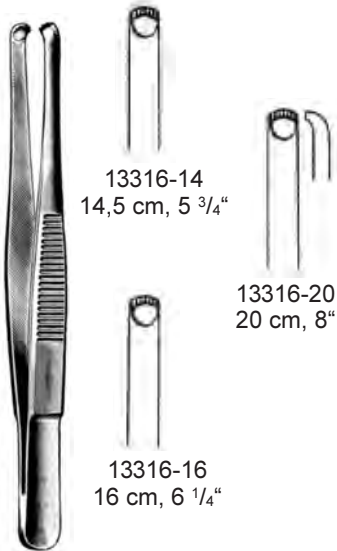

13316-14
14,5 cm, 5 3/4"

13316-20
20 cm, 8"

13316-16
16 cm, 6 1/4"

DURANTE

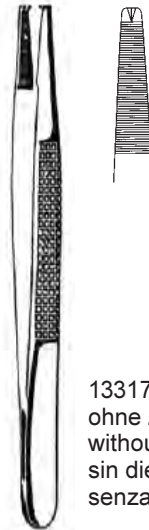

13317-00
ohne Zähne
without teeth
sin dientes
senza denti

13317-12 1x2
13317-23 2x3
13319-12 TC 1x2

BONNEY
18 cm, 7"

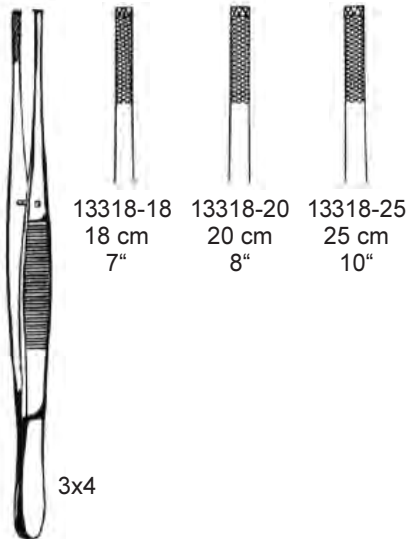

13318-18
18 cm
7"

13318-20
20 cm
8"

13318-25
25 cm
10"

3x4

STILLE-BARRAYA



OCHSNER
13319-14
14,5 cm, 5 3/4"



SINGLEY
13320-18 18 cm, 7"
13320-23 23 cm, 9"

Splitterpinzetten
Splinter Forceps
Pinzas para espinas
Pinze per schegge

Fig.: 1



13401-01
12 cm, 4 3/4"

3



13403-03
12 cm, 4 3/4"

3c



13403-04
11 cm, 4 3/8"

Fig.: 4



13404-04
11 cm, 4 3/8"

5



13405-05
11 cm, 4 3/8"

7



13407-07
12 cm, 4 3/4"

Mikro- Knüpfpinzetten
 Micro Suture Tying Forceps
 Micro pinzas para ligaduras
 Micro pinze per legature



	0,3 mm	0,8 mm
12 cm, 4 ³ / ₄ "	14102-12 14102-12D	
15 cm, 6"	14104-15 14104-15D	
18 cm, 7"		14108-18 14108-18D
21 cm, 8 ¹ / ₄ "		14102-21 14102-21D
23 cm, 9"		14102-23 14102-23D



	0,3 mm	0,8 mm
12 cm, 4 ³ / ₄ "	14103-12 14103-12D	
15 cm, 6"	14103-15 14103-15D	
18 cm, 7"		14109-18 14109-18D
21 cm, 8 ¹ / ₄ "		14109-21 14109-21D
23 cm, 9"		14109-23 14109-23D



1x2

	0,3 mm	0,3 mm
15 cm, 6"	14090-15D	14091-15D
	0,4 mm	0,4 mm
18 cm, 7"	14090-18D	14091-18D
	0,8 mm	0,8 mm
21 cm, 8 ¹ / ₄ "	14090-21D	14091-21D
23 cm, 9"	14090-23D	14091-23D



1x2

D = mit diamantiertem Maul
 with diamond jaw
 con boca de diamante
 con morso diamantato

—MT- Braun Instrumente

Mikro- Ring-Pinzette mit diamantiertem Maul + TITAN
Micro Ring Forceps with Diamond Jaw + Titanium
Micro Pinzas con anillo con boca de diamante + Titanio
Micro Pinza ad anello con morso diamantato +Titanio



	Ø 1 mm x 0,5 mm	Ø 2 mm x 1 mm
15 cm, 6"	14112-15D 14112-15T	14114-15D 14114-15T
18 cm, 7"	14112-18D 14112-18T	14114-18D 14114-18T
21 cm, 8 ¹ / ₄ "	14112-21D 14112-21T	14114-21D 14114-21T
23 cm, 9"	14112-23D 14112-23T	14114-23D 14114-23T

D = mit diamantiertem Maul
with diamond jaw
con boca de diamante
con morso diamantato
T = Titan, titanium, titanio, titanio

Atrauma- Mikro- Pinzette
Atrauma Micro Forceps
Micro pinza atraumaticas
Micro Pinza Atraumatica

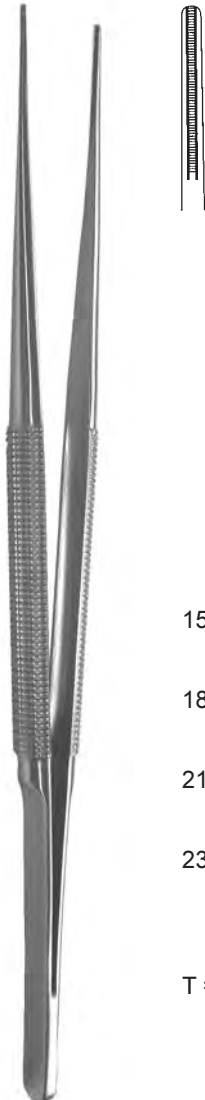

	1,2 mm	2,0 mm
15 cm, 6"	14115-15 14115-15T	14116-15
18 cm, 7"	14115-18 14115-18T	14116-18
21 cm, 8 ¹ / ₄ "	14115-21 14115-21T	14116-21
23 cm, 9"	14115-23 14115-23T	14116-23

T = Titan, titanium, titanio, titanio

De BAKEY

— MT- Braun Instrumente

TC Atrauma Pinzette
TC Atrauma Forceps
Pinza atraumaticas con TC
Pinza Atraumatica TC



	1,2 mm	2,0 mm
18 cm, 7"	14117-18 TC	14118-18 TC
21 cm, 8 1/4"	14117-21 TC	14118-21 TC
23 cm, 9"	14117-23 TC	14118-23 TC

De BAKEY TC

Atraumatische Pinzetten
 Atraumatic Tissue Forceps
 Pinzas atraumaticas
 Pinze Atraumatiche



DE BAKEY
 14302-16 16 cm, 6 1/4"
 14302-20 20 cm, 8"
 14302-24 24 cm, 9 1/2"



DE BAKEY
 14306-16 16 cm, 6 1/4"
 14306-20 20 cm, 8"
 14306-24 24 cm, 9 1/2"
 14306-30 30 cm, 11 3/4"



DE BAKEY
 14308-16 16 cm, 6 1/4"
 14308-20 20 cm, 8"
 14308-24 24 cm, 9 1/2"
 14308-30 30 cm, 11 3/4"



DE BAKEY
 14309-16 16 cm, 6 1/4"
 14309-20 20 cm, 8"
 14309-24 24 cm, 9 1/2"
 14309-30 30 cm, 11 3/4"



DE BAKEY
 14304-16 16 cm, 6 1/4"
 14304-20 20 cm, 8"
 14304-24 24 cm, 9 1/2"
 14304-30 30 cm, 11 3/4"



DE BAKEY
 14310-16 16 cm, 6 1/4"
 14310-20 20 cm, 8"
 14310-24 24 cm, 9 1/2"
 14310-30 30 cm, 11 3/4"

MT- Braun Instrumente

Iris Pinzetten
Iris Forceps
Pinzas para iris
Pinze per iride



GRAEFE
45810-10
10 cm, 4"



GRAEFE
45811-10
10 cm, 4"



GRAEFE
45813-10
10 cm, 4"



GRAEFE
45820-10
10 cm, 4"



GRAEFE
45821-10
10 cm, 4"



GRAEFE
45823-10
10 cm, 4"

Iris Pinzetten
Iris Forceps
Pinzas para iris
Pinze per iride



BISHOP-HARMAN
45940-05 8,5 cm, 3.4"
0,5 mm



BISHOP-HARMAN
45940-08 8,5 cm, 3.4"
0,8 mm



1x2

BISHOP-HARMAN
45942-05 8,5 cm, 3.4"
0,5 mm



1x2

BISHOP-HARMAN
45942-08 8,5 cm, 3.4"
0,8 mm

— MT- Braun Instrumente

Nahtpinzetten
Suture forceps
Pinzas para sutura
Pinza per sutura



MOD. TUEBINGEN
45950-10
10 cm, 4"



MOD. BONN
45952-10
10 cm, 4" / 0,12 mm



MOD. TUEBINGEN
45953-10
10 cm, 4"

Muskelpinzetten, Nahtpinzetten, Chalazionspinzetten, Cilienpinzetten
 Muscle Forceps, Suture forceps, Forceps for Chalazion, Cilia Forceps
 Pinzas musculares, Pinza para sutura, Pinzas de chalazión, Pinza depilatorias
 Pinza muscolare, Pinza per sutura, Pinze per calazio, Pinza depilatoria

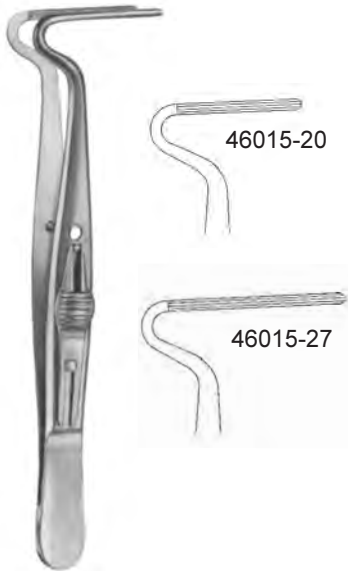

BERKE
 10 cm, 4"



auch mit breitem Griff verfügbar also
 available with broad handle también
 disponible con apoyo ancho
 disponibile con impugnatura larga

- 46150-01 0,12 mm
- 46150-03 0,30 mm
- 46150-05 0,50 mm
- 46150-10 1,00 mm
- 46150-15 1,50 mm

CASTROVIEJO
 10 cm, 4"



DESMARRES
 9 cm, 3 1/2"

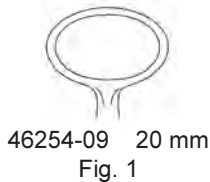

BARRAQUER
 46425-10 10,5 cm, 4 1/4"

— MT- Braun Instrumente

Fixierpinzetten
Fixation forceps
Pinzas para fijación
Pinze fissatrici



GREEN
10 cm, 4"

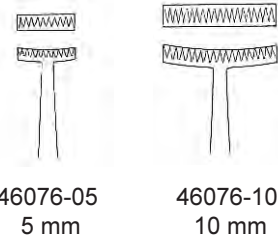

ohne Sperre
without catch
sin cierre
senza cremagliera

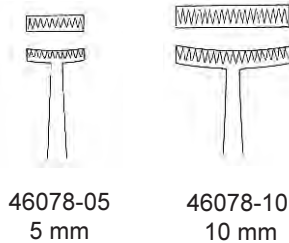

mit Sperre
with catch
con cierre
con cremagliera

Ohrpinzetten, Columellapinzette
Ear Forceps, Columella Forceps
Pinzas auriculares, Pinza para columela
Pinze auricolari, Pinza per columella



WILDE (TROELTSCH)
47201-11 11 cm, 4³/₈"



LUCAE
47206-14 14 cm, 5¹/₂"
47206-16 16 cm, 6¹/₄"



COTTLE
47208-14 14 cm, 5¹/₂"



TROELTSCH
49151-15 15 cm, 6"
49151-18 18 cm, 7"



JANSEN-GRUENWALD
49154-20 20 cm, 8"



COTTLE
49565-10 10 cm, 4"



—MT- Braun Instrumente

Lidplatte
Lid Plate
Placa para párado
Placca per palpebre



JAEGER 45150-11
11 cm, 4³/₈"

Arterienklemmen
Artery Forceps
Pinzas hemostáticas
Pinze emostatiche



HARTMANN
15210-10 10 cm, 4"

Micro - HARTMANN
15214-10 10 cm, 4"



HARTMANN
15211-10 10 cm, 4"

Micro - HARTMANN
15215-10 10 cm, 4"

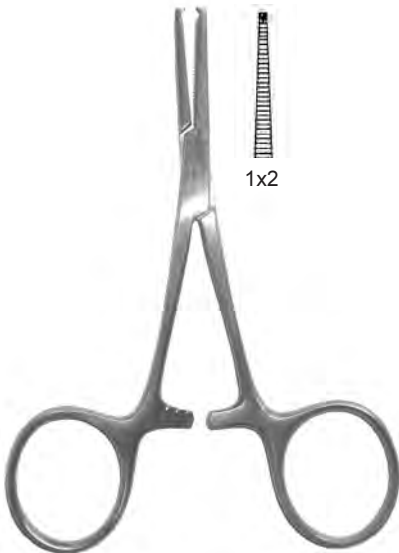

HARTMANN
15212-10 10 cm, 4"

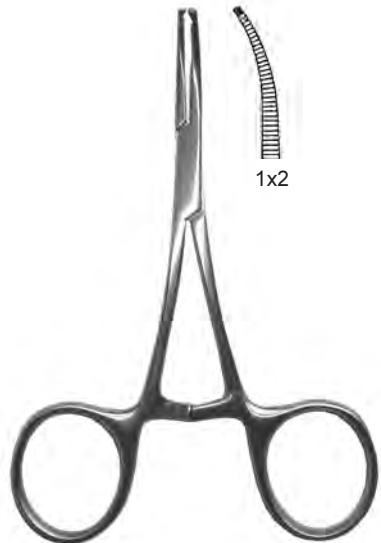

HARTMANN
15213-10 10 cm, 4"

—MT- Braun Instrumente

Arterienklemmen
 Artery Forceps
 Pinzas hemostáticas
 Pinze emostatiche



HALSTED-MOSQUITO

- | | | | | |
|------------------|----------|--------------|----------|------------------|
| 15224-12T | 15220-12 | 12,5 cm, 5" | 15221-12 | 15225-12T |
| | 15220-14 | 14,0 cm, 5½" | 15221-14 | |
| | 15220-18 | 18,0 cm, 7" | 15221-18 | |
| | 15220-21 | 21,0 cm, 8¼" | 15221-21 | |



HALSTED-MOSQUITO micro

- | | | |
|----------------|--------------|----------|
| 15222-12 | 12,5 cm, 5" | 15223-12 |
| JACOBSEN micro | | |
| 15226-12 | 21,0 cm, 8¼" | 15227-12 |

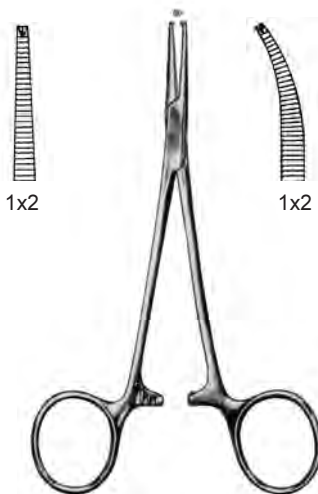

HALSTED-MOSQUITO

- | | | |
|----------|--------------|----------|
| 15230-12 | 12,5 cm, 5" | 15231-12 |
| 15230-14 | 14,0 cm, 5½" | 15231-14 |
| 15230-18 | 18,0 cm, 7" | 15231-18 |
| 15230-21 | 21,0 cm, 8¼" | 15231-21 |

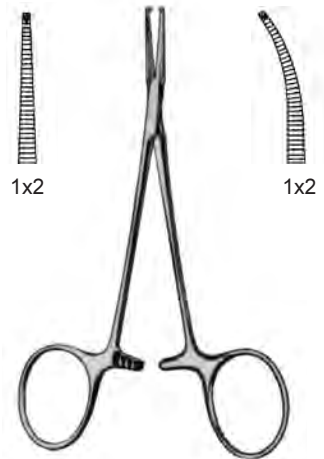

HALSTED-MOSQUITO micro

- | | | |
|----------|------------|----------|
| 15232-12 | 12 cm, 4¾" | 15233-12 |
|----------|------------|----------|

Arterienklemmen
 Artery Forceps
 Pinzas hemostáticas
 Pinze emostatiche

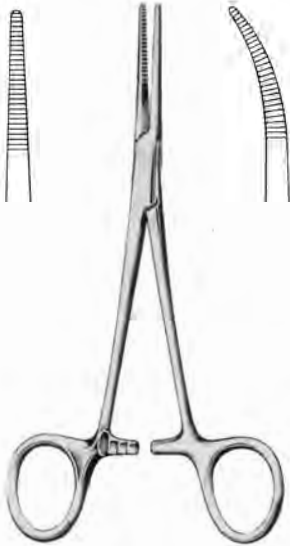

KELLY

15240-14	14 cm, 5 1/2"	15241-14
15240-18	18 cm, 7"	15241-18
15244-14	14 cm, 5 1/2"	15245-14

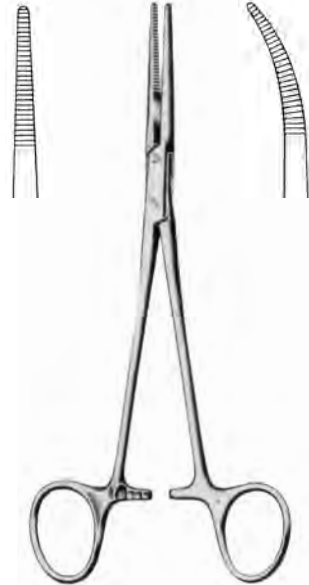

KELLY-RANKIN

15242-16	16 cm, 6 1/4"	15243-16
----------	---------------	----------

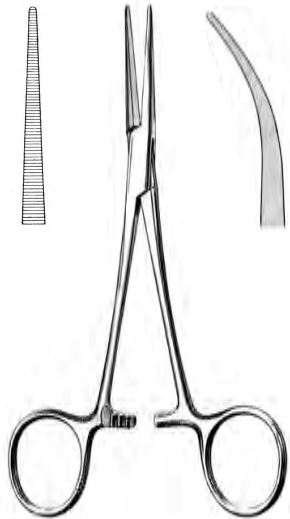

COLLER-CRILE

15256-14	14 cm, 5 1/2"	15257-14
15258-16	16 cm, 6 1/4"	15259-16

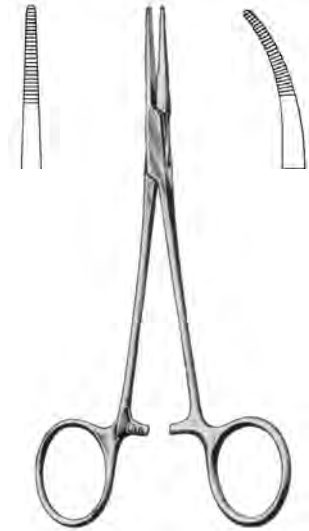

PROVIDENCE-HOSPITAL

15270-14	14 cm, 5 1/2"	15271-14
----------	---------------	----------

MT- Braun Instrumente

Arterienklemmen
 Artery Forceps
 Pinzas hemostáticas
 Pinze emostatiche

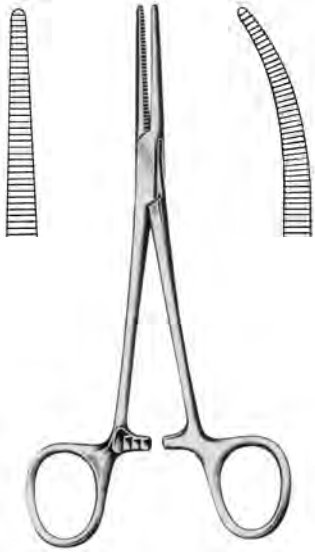

CRILE
 15250-14 14 cm, 5 1/2" 15251-14
 15250-18 18 cm, 7" 15251-18
 15254-14 14 cm, 5 1/2" 15255-14

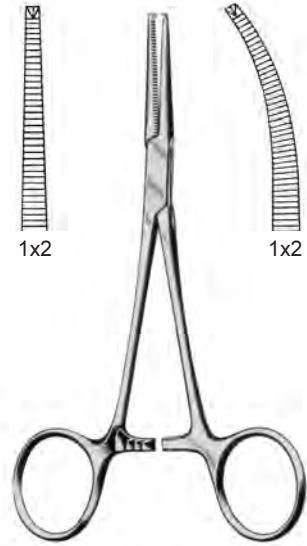

CRILE
 15260-14 14 cm, 5 1/2" 15261-14

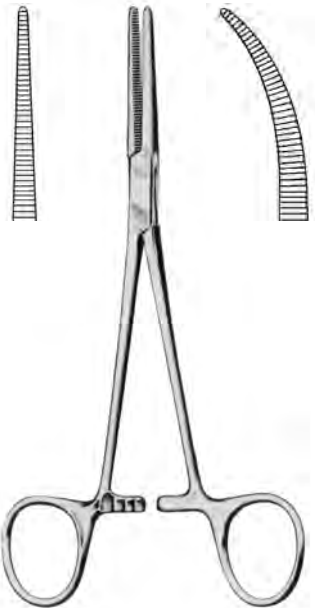

CRILE-RANKIN
 15262-16 16 cm, 6 1/4" 15263-16

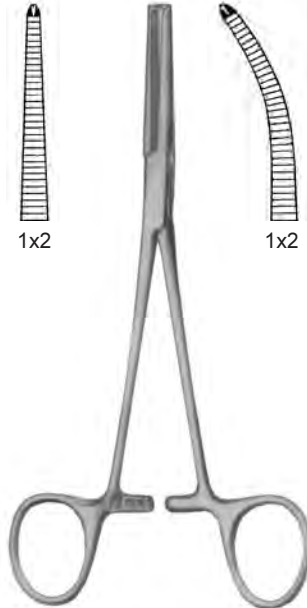

CRILE-RANKIN
 15264-16 16 cm, 6 1/4" 15265-16

Arterienklemmen
 Artery Forceps
 Pinzas hemostáticas
 Pinze emostatiche

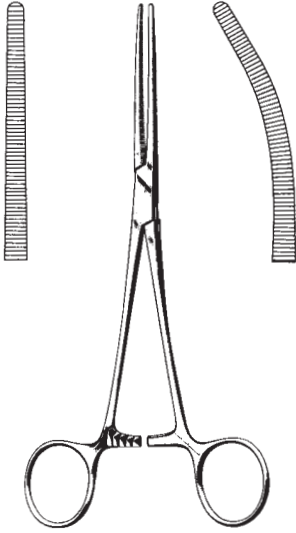

ROCHESTER-PEAN

15310-13 13,0 cm, 5¹/₈" 15311-13
 15310-14 14,0 cm, 5¹/₂" 15311-14
 15310-16 16,0 cm, 6¹/₄" 15311-16

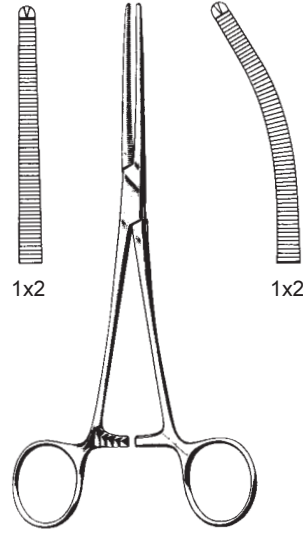

ROCHESTER-OGHSNER

15320-13 13,0 cm, 5¹/₈" 15321-13
 15320-14 14,0 cm, 5¹/₂" 15321-14
 15320-16 16,0 cm, 6¹/₄" 15321-16

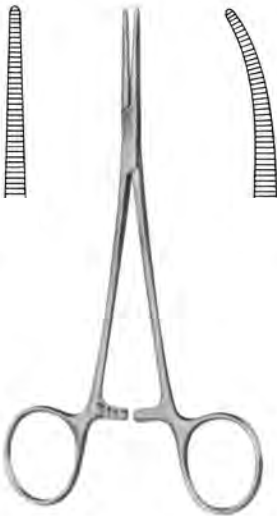

LERICHE

15380-15 15 cm, 6" 15381-15

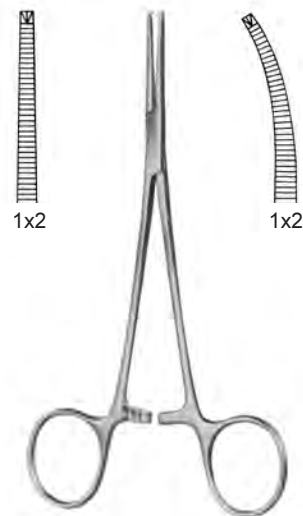

LERICHE

15382-15 15 cm, 6" 15383-15

— MT- Braun Instrumente

Arterienklemmen
Artery Forceps
Pinzas hemostáticas
Pinze emostatiche

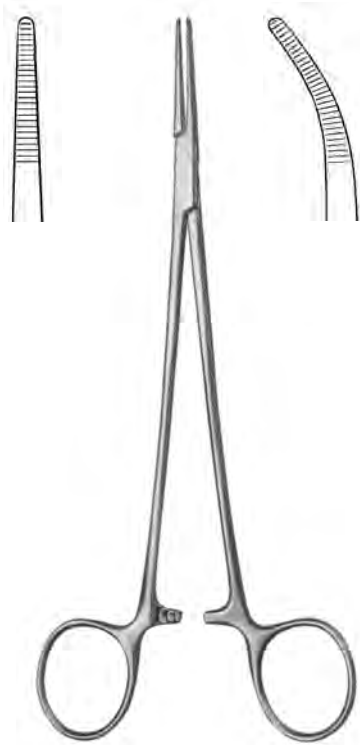

ADSON
15410-18 18,5 cm, 7¹/₄" 15411-18

Wundhaken
Retractors
Separadores
Divaricatori

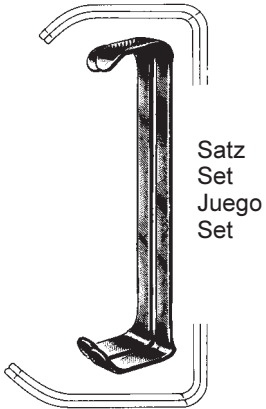

Satz
Set
Juego
Set

FARABEU
21102-12
12 cm, 4³/₄"



Satz
Set
Juego
Set

FARABEU
21102-15
15 cm, 6"



ROUX mini
21124-15
14 cm, 5¹/₂"



RAGNELL
21125-14
14 cm, 5¹/₂"

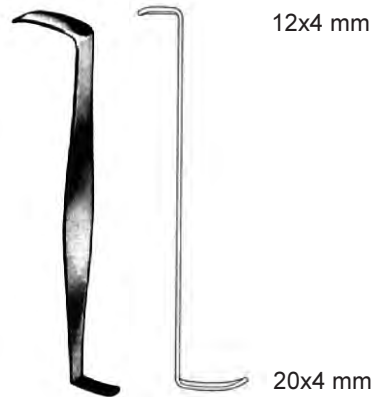

CRILE
21127-11
13 cm, 5¹/₈"

—MT- Braun Instrumente

Bauch- und Darmspatel, biegsam
Abdominal and Intestinal Spatulas, malleable
Espátulas abdominales e intestinales, maleables
Spatole addominali e intestinali, malleabili



RIBBON

21168-06	6x200 mm
21168-08	8x200 mm
21168-10	10x200 mm
21168-12	12x200 mm
21168-17	17x200 mm
21168-20	20x200 mm
21168-25	25x200 mm
21169-25	25x250 mm



RIBBON

21170-20	20x330 mm
21170-25	25x330 mm
21170-32	32x330 mm
21170-40	40x330 mm
21170-45	45x330 mm
21170-50	50x330 mm
21170-65	65x330 mm
21170-76	76x330 mm

Wundhaken
Retractors
Separadores
Divaricatori



19 mm

DEAVER
21180-19
19 cm, 7½"



22 mm

DEAVER
21181-22
21,5 cm, 8½"



25 mm

DEAVER
21181-25
23 cm, 9"



25 mm

DEAVER
21183-25
30 cm, 11¾"



25 mm

DEAVER
21185-25
33 cm, 13"



25 mm

DEAVER
21187-25
36 cm, 14"



MT- Braun Instrumente

Wundhaken
Retractors
Separadores
Divaricatori



FREEMAN
21188-12
20 cm, 8", 12 mm wide



FREEMAN
21188-12CL
20 cm, 8", 12 mm wide

mit Kaltlicht + Absaugung
with cold light + aspiration
con luz fria + aspiración
con luce fredda + aspirazione

Feine Wundhaken
Retractors
Separadores
Divaricatori



GRAEFE
21210-12

scharf
sharp
agudo
acuto



GRAEFE
21211-12

stumpf
blunt
romo
smusso



12 cm, 4³/₄"



GUTHRIE
21212-01

scharf
sharp
agudo
acuto



GUTHRIE
21212-02



TYRELL
21213-12
12 cm, 4³/₄"

scharf
sharp
agudo
acuto

—MT- Braun Instrumente

Feine Wundhaken
 Retractors
 Separadores
 Divaricatori



FRAZIER

A	scharf	B	stumpf
	sharp		blunt
	agudo		romo
	acuto		smusso

A	21214-13	13 cm, 5 ¹ / ₈ "
A	21214-18	18 cm, 7"
B	21215-13	13 cm, 5 ¹ / ₈ "
B	21215-18	18 cm, 7"



LAHEY
 12 cm, 4³/₄"



21215-01



21215-02



21215-03



JOSEPH
 16 cm, 6¹/₄"



21216-01
 1 mm



21216-02
 2 mm



21216-05
 5 mm



21216-07
 7 mm



21216-10
 10 mm



KLEINERT-KUTZ
 13 cm, 5¹/₈"



21217-03



21217-05



21217-07

Feine Wundhaken
Retractors
Separadores
Divaricatori



BARSKY
21218-01
15 cm, 6"



BARSKY
21218-02
15 cm, 6"



HUMBY
21218-11
11,5 cm, 4½"

MT- Braun Instrumente

Wundhaken
Retractors
Separadores
Divaricatori

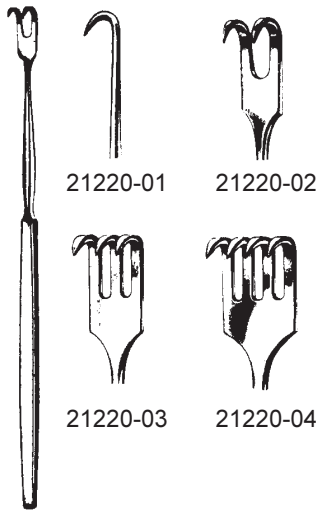

21220-01

21220-02

21220-03

21220-04

Mt-Braun Intrumente
16 cm, 6 1/4"

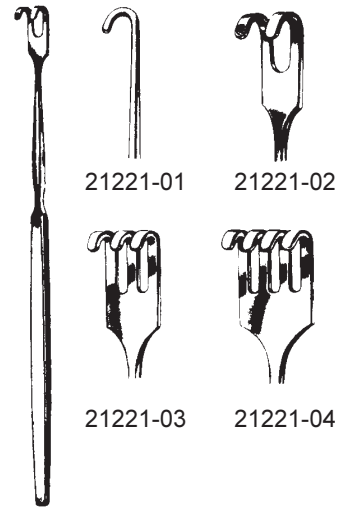

21221-01

21221-02

21221-03

21221-04

Mt-Braun Intrumente
16 cm, 6 1/4"

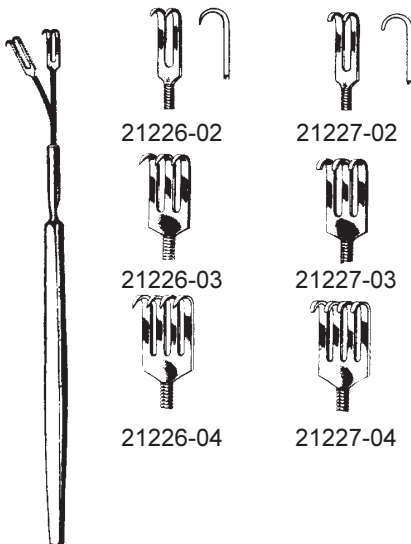

21226-02

21227-02

21226-03

21227-03

21226-04

21227-04

Mt-Braun Intrumente,
flexibel 16 cm, 6 1/4"



21229-02

21229-03

KLAPP
17,5 cm, 6.9"

Wundhaken
Retractors
Separadores
Divaricatori



DESMARRES
21230-00 16 cm, 6 1/4"

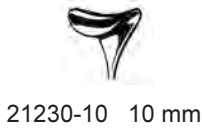

21230-10 10 mm



21230-16 16 mm



21230-12 12 mm



21230-18 18 mm



21230-14 14 mm



DESMARRES
21234-00 14 cm, 5 1/2"



KASDAN
21237-16 16 cm, 6 1/4"



VOLKMANN
11,5 cm, 4 1/2"



21270-02



21271-02



21270-03



21271-03



21270-04



21271-04



21270-06



21271-06

—MT- Braun Instrumente

Wundhaken
Retractors
Separadores
Divaricatori



MEYERDING
18 cm, 7"



21302-01 18x7 mm

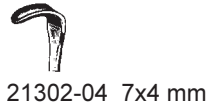

21302-04 7x4 mm



21302-02 16x5 mm



21302-05 10x3 mm



21302-03 7x4 mm



21302-06 10x4 mm



STRANDELL-STILLE
17 cm, 6³/₄"



21307-01

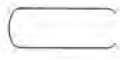

21307-02

Wundsperrer
Retractors
Separadores
Divaricatori

3x4



spitz
sharp
agudo
acuto

stumpf
blunt
romo
smusso

FINSEN

21610-07 7 cm, 2³/₄" 21611-07

4x4



spitz
sharp
agudo
acuto

stumpf
blunt
romo
smusso

ALM

21620-07 7 cm, 2³/₄" 21621-07
21620-10 10 cm, 4" 21621-10

3x3



spitz
sharp
agudo
acuto

stumpf
blunt
romo
smusso

JANSEN

21630-10 10 cm, 4" 21631-10

4x4



spitz
sharp
agudo
acuto

stumpf
blunt
romo
smusso

HOLZHEIMER 21634-10 10
cm, 4" 21635-10

— MT- Braun Instrumente

Wundsperrer
Retractors
Separadores
Divaricatori

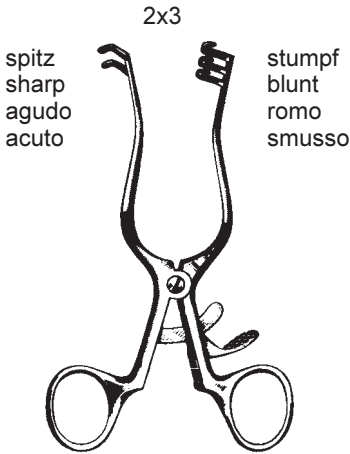

WEITLANER
21650-10 11,5 cm, 4 1/2" 21651-10

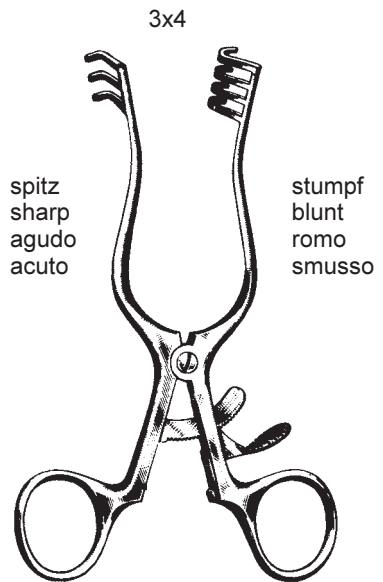

WEITLANER
21670-14 14 cm, 5 1/2" 21671-14

Endo Dissektoren
Endo dissectors
Disectores
Dissettori



24 cm, 9 1/2"



21741-01 LANGENBECK, 5,0 mm
21741-02 LANGENBECK, 7,0 mm
21741-03 LANGENBECK, 10,0 mm



21741-04 LANGENBECK, 5,0 mm
21741-05 LANGENBECK, 7,0 mm
21741-06 LANGENBECK, 10,0 mm



21741-07 LANGENBECK, 12,5 mm



21741-08 LANGENBECK-COTTLE 7,0 mm



21741-09 LANGENBECK-COTTLE, 7,0 mm



21741-10 LANGENBECK
konkav, concave, concavo, concavo



21741-11 Mini-LANGENBECK



Nervenhaken / nerve hook
gancho para nervios / uncino p. nervi

21741-12 links / left / izquierda / sinistra
21741-13 rechts / right / derecha / destra

MT- Braun Instrumente

Wundhaken für plastische Chirurgie
Retractors for plastic surgery
Separadores para cirugía plástica
Divaricatore per chirurgia plastica



FERRIERA

21960-01	80 mm x 16 mm
21960-02	100 mm x 25 mm
21960-03	120 mm x 25 mm
21960-04	120 mm x 30 mm
21960-05	150 mm x 25 mm
21960-06	150 mm x 30 mm



mit Kaltlicht + Absaugung
with cold light + aspiration
con luz fria + aspiracion
con luce fredda + aspirazione

TEBBETTS

21980-01	80 mm x 16 mm
21980-02	100 mm x 25 mm
21980-03	120 mm x 25 mm
21980-04	120 mm x 30 mm
21980-05	150 mm x 25 mm
21980-06	150 mm x 30 mm

MT- Braun Instrumente

Wundhaken für plastische Chirurgie
 Retractors for plastic surgery
 Separadores para cirugía plástica
 Divaricatore per chirurgia plastica



BREAST
 21970-01 31 cm, 12¹/₄"



CORONAL
 21980-18 18 cm, 7"



YANKOSKIE
 21990-18 18 cm, 7"



YANKOSKIE
 21991-18
 23 cm, 9", 150 mm wide



FREEMAN
 21995-22
 18 cm, 7", 22 mm
 21995-38
 18 cm, 7", 38 mm wide

3 Finger
 3 prongs
 3 dientes
 3 rebbi



5 Finger
 5 prongs
 5 dientes
 5 rebbi

ANDERSON
 21998-03 12 cm, 4³/₄" 21998-05

Spatel
Spatula
Espatula
Spatola

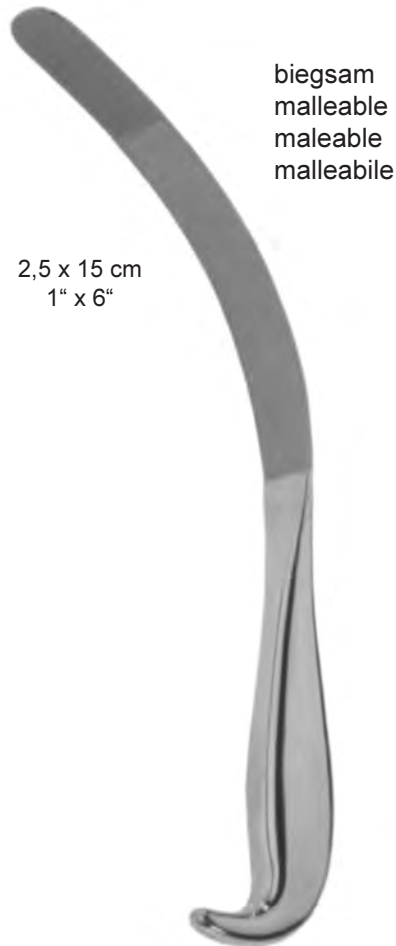

biegsam
malleable
maleable
malleabile

2,5 x 15 cm
1" x 6"

21992-31
31,5 cm, 12¹/₂"

MT- Braun Instrumente

Wundhaken für plastische Chirurgie
Retractors for plastic surgery
Separadores para cirugía plástica
Divaricatore per chirurgia plastica



GORNEY
21996-04
7,5 cm, 3", 38 mm



FREEMAN
21997-09
9 cm, 3 1/2", 20 mm

Brustdissektoren
Breast Dissectors
Separadores mamarios
Separatori mammari



Satz
Set
Juego
Set

AGRIS-DINGMAN
21999-00 36 cm, 14"

Brustdissektoren
Breast Dissectors
Separadores mamarios
Separatori mammari



MacCOLLUM-DINGMAN
21999-01
41 cm, 16"



TEBBETTS
21999-02
33 cm, 13"



TEBBETTS
21999-03
33 cm, 13"



SILVERSTEIN
21999-04
35,6 cm, 14"

—MT- Braun Instrumente

Wundhaken für plastische Chirurgie
Retractors for plastic surgery
Separadores para cirugía plástica
Divaricatore per chirurgia plastica



BIGGS

21999-30	30 mm
21999-50	50 mm

21999-30 CL	30 mm
21999-50 CL	50 mm

CL = mit Kaltlicht + Absaugung
with cold light + aspiration
con luz fria + aspiracion
con luce fredda + aspirazione

Nervenhaken, Durahaken
Nerve Hooks, Dura Hooks
Ganchos para nervios y para duramadre
Unicini per nervi e per dura-madre



CRILE
43054-20
20 cm, 8"



CUSHING
43056-18
18 cm, 7"



CUSHING
43058-18
18 cm, 7"



scharf
sharp
agudo
acuto

ADSON
43068-20
20 cm, 8"



stumpf
blunt
romo
smusso

ADSON
43069-20
20 cm, 8"

—MT- Braun Instrumente

Feine Wundhaken
Retractors
Separadores
Divaricatori



spitz
sharp
agudo
acuti

O'CONNOR
45370-12
12 cm, 4³/₄"



spitz
sharp
agudo
acuti

WIENER
45372-13
13 cm, 5¹/₈"



stumpf
blunt
romo
smussi

WIENER
45373-13
13 cm, 5¹/₈"



spitz
sharp
agudo
acuti

ROLLET
45376-13
13,5 cm, 5¹/₄"

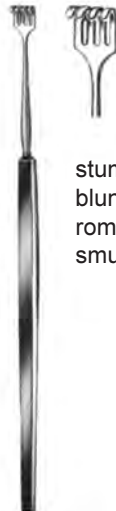

stumpf
blunt
romo
smussi

KNAPP
45377-13
13 cm, 5¹/₈"



spitz
sharp
agudo
acuti

MILLER
45378-13
13 cm, 5¹/₈"

Nasenhaken
Nasal retractors
Separadores nasales
Reatrattori nasali



CONVERSE

- 49538-01 9 cm, 3 1/2" 18 x 9,5 mm
- 49538-02 9 cm, 3 1/2" 28 x 12,5 mm
- 49538-03 9 cm, 3 1/2" 41 x 13,5 mm
- 49538-04 9 cm, 3 1/2" 53 x 13,5 mm



COTTLE
49540-16
16 cm, 6 1/4"



MALINIAC
49550-11
11 cm, 4 3/8"

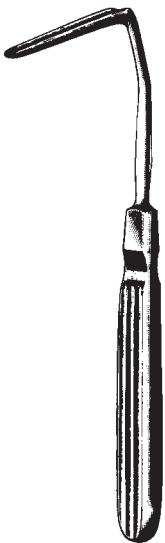

AUFRICHT
49551-16
16 cm, 6 1/4"



AUFRICHT
49551-16L
16 cm, 6 1/4"



MASING-NEIVERT
49552-16
16 cm, 6 1/4"



10 x 12 mm

COTTLE
49553-15
15 cm, 6"

—MT- Braun Instrumente

Hauthäkchen, Nasenhaken
 Skin hook, Nasal retractors
 Gancho para piel, Separadores nasales
 Uncino per pelle, Retrattori nasali



COTTLE
 14,5 cm, 5³/₄"

3 x 11 mm



KILNER
 49555-08 8 cm, 3¹/₈"



FOMON
 49556-16 16 cm, 6¹/₄"



FOMON
 49557-17 17 cm, 6³/₄"



FREER
 49558-15 15 cm, 6"



COTTLE-NEIVERT
 49559-20 20 cm, 8"

Feine Wundhaken
Retractors
Separadores
Divaricatori

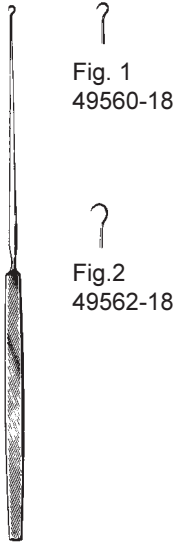

GILLIES
18 cm, 7"



LANGE 49563-22
23 cm, 9"



COTTLE
49564-16 16 cm, 6 1/4"



CONVERSE 49566-12
12 cm, 4 3/4"



MARTINEZ-KILNER
49567-11 11 cm, 4 3/8"



COTTLE
49568-08

—MT- Braun Instrumente

Trachealhaken
Trachea Hooks
Ganchos para traqueotomía
Ganci per tracheotomia

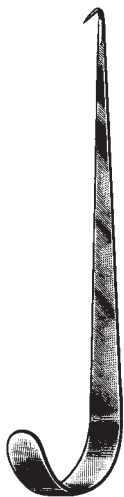

JACKSON
57116-15
15 cm, 6"



JACKSON
57117-17
17 cm, 6³/₄"



NEWS
57120-15
15 cm, 6"

Nadelhalter
Needle Holders
Porta-agujas
Portaghi



DERF
27110-12 12 cm, 4³/₄" 27114-12 TC



WEBSTER
27128-13 13 cm, 5¹/₈"
27129-13 TC 13 cm, 5¹/₈"



HALSEY
27130-13 13 cm, 5¹/₈" 27140-13
27134-13 TC 13 cm, 5¹/₈" 27144-13

MT- Braun Instrumente

Nadelhalter
 Needle Holders
 Porta-agujas
 Portaghi



BAUMGARTNER

- | | | |
|----------|-----------------|-------------|
| 27150-12 | 12,5 cm, 5" | 27154-12 TC |
| 27150-14 | 14,0 cm, 5 1/2" | 27154-14 TC |



CRILE-WOOD

- | | | |
|----------|-----------|-------------|
| 27160-15 | 15 cm, 6" | 27164-15 TC |
| 27160-18 | 18 cm, 7" | 27164-18 TC |
| | 20 cm, 8" | 27164-20 TC |
| | 23 cm, 9" | 27164-23 TC |



MAYO-HEGAR

- | | | |
|----------|---------------|-------------|
| 27180-12 | 12 cm, 4 3/4" | 27184-12 TC |
| 27180-14 | 14 cm, 5 1/2" | 27184-14 TC |
| 27180-16 | 16 cm, 6 1/4" | 27184-16 TC |
| 27180-18 | 18 cm, 7" | 27184-18 TC |
| 27180-20 | 20 cm, 8" | 27184-20 TC |



DeBAKEY

- | | |
|-------------|---------------|
| 27214-16 TC | 16 cm, 6 1/4" |
| 27214-18 TC | 18 cm, 7" |
| 27214-20 TC | 20 cm, 8" |
| 27214-23 TC | 23 cm, 9" |

Nadelhalter
Needle Holder
Porta-agujas
Portaghi

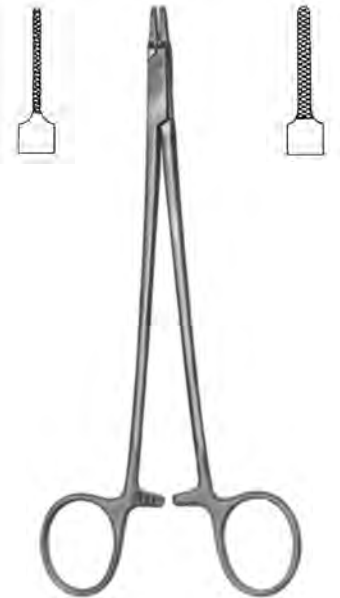

1 mm RYDER 2 mm

- | | | |
|------------|--|-------------|
| 27224-13TC | 13 cm, 5 ¹ / ₈ " | 27225-13 TC |
| 27224-15TC | 15 cm, 6" | 27225-15 TC |
| 27224-16TC | 16 cm, 6 ¹ / ₄ " | 27225-16 TC |
| 27224-18TC | 18 cm, 7" | 27225-18 TC |
| 27224-20TC | 20 cm, 8" | 27225-20 TC |



MICROVASCULAR

- | | |
|------------|-----------|
| 27230-18TC | 18 cm, 7" |
| 27230-20TC | 20 cm, 8" |



BABY OLSEN-HEGAR

- | | | |
|------------|--|------------|
| 27405-12 | 12 cm, 4 ³ / ₄ " | 27406-12 |
| 27408-12TC | 12 cm, 4 ³ / ₄ " | 27407-12TC |

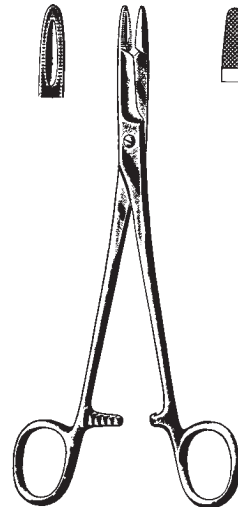

OLSEN-HEGAR

- | | | |
|----------|--|------------|
| 27410-14 | 14 cm, 5 ¹ / ₂ " | 27414-14TC |
| 27410-17 | 17 cm, 6 ³ / ₄ " | 27414-17TC |
| | 18 cm, 7" | 27414-18TC |

— MT- Braun Instrumente —

Nadelhalter
Needle Holders
Porta-agujas
Portaghi



GILLIES

27434-11TC	11 cm, 4 ³ / ₈ "
27434-13TC	13 cm, 5 ¹ / ₈ "
27434-16TC	16 cm, 6 ³ / ₈ "

Mikro-Nadelhalter
Micro Needle Holders
Micro-porta-agujas
Micro portaghi

ohne Sperre
without lock
sin cremallera
senza cremagliera

mit Sperre
with lock
con cremallera
con cremagliera



BARRAQUER

11,5 cm, 4 1/2"
13,0 cm, 5 1/8"
14,0 cm, 5 1/2"
18,0 cm, 7"
21,0 cm, 8 1/4"
23,0 cm, 9"



27660-12
27660-13
27660-14
27700-18



27661-12
27661-13
27661-14
27701-18



27720-12
27720-13
27720-14
27730-18
27730-21
27730-23



27731-12
27731-13
27731-14
27731-18
27731-21
27731-23

mit diamantiertem Maul
with diamond jaw
con boca de diamante
con morso diamantato

11,5 cm, 4 1/2"
13,0 cm, 5 1/8"
14,0 cm, 5 1/2"
18,0 cm, 7"
21,0 cm, 8 1/4"
23,0 cm, 9"

27720-12D 25671-12D
27720-13D 25671-13D
27720-14D 25671-14D
25730-18D 25731-18D
25730-21D 25731-21D
25730-23D 25731-23D

T= Titan, titanium, titanio, titanio



95250-15T
95250-18T
95250-21T



95251-15T
95251-18T
95251-21T



95260-15T
95260-18T
95260-21T



95261-15T
95261-18T
95261-21T

— MT- Braun Instrumente

Mikro-Nadelhalter mit Sperre
 Micro Needle Holders, with lock
 Micro-porta-agujas con cremallera
 Micro portaghi, con cremagliera



14,0 cm, 5 1/2"
 18,0 cm, 7"
 21,5 cm, 8 1/2"
 23,0 cm, 9"

27670-14
 27670-18
 27670-21

27671-14
 27671-18

27672-14
 27672-18
 27672-21
 27672-23

27673-14
 27673-18

mit TC 1,4 mm
 with TC jaw 1,4 mm
 con TC 1,4 mm
 con morso in TC 1,4 mm

14,0 cm, 5 1/2"
 18,0 cm, 7"
 21,5 cm, 8 1/2"
 23,0 cm, 9"

27674-14	27675-14	27676-14	27677-14
27674-18	27675-18	27668-18	27691-18
27674-21		27668-21	
		27668-23	

mit diamantiertem Maul 0,8 mm
 with diamond jaw 0,8 mm
 con boca de diamante 0,8 mm
 con morso diamantato 0,8 mm

14,0 cm, 5 1/2"
 18,0 cm, 7"
 21,5 cm, 8 1/2"
 23,0 cm, 9"

27672-14D 27673-14D
 27672-18D 27673-18D
 27672-21D
 27672-23D

T= Titan, titanium, titanio, titanio
 Maul/jaw/boca/morso 0,4mm

14,0 cm, 5 1/2"
 18,0 cm, 7"
 21,5 cm, 8 1/2"

27672-14T	27673-14T
27672-18T	27673-18T
27672-21T	27673-21T

CASTROVIEJO

Drahtzangen
Wire Twisting Forceps
Pinza para torcer hilos
Pinza torcifili



MAYO-HABERISSER TC



36554-15 TC 15 cm, 6" 36555-15 TC



36554-18 TC 18 cm, 7" 36555-18 TC



36554-20 TC 20 cm, 8" 36555-20 TC



BERRY TC

36556-18TC 18 cm, 7"

-MT- Braun Instrumente

Hohlmeißelzange
 Bone Rongeurs
 Pinzas-gubias
 Pinze sgorbie

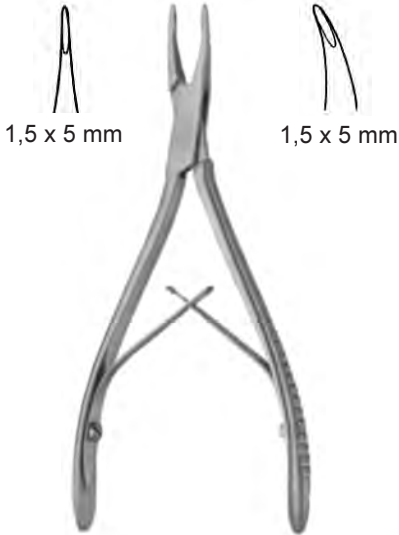

MICRO FRIEDMANN
 35100-01 14,5 cm, 5³/₄" 35100-02



FRIEDMANN MINI
 35101-12 12 cm, 4³/₄"



FRIEDMANN
 35101-14 14 cm, 5¹/₂"



BEYER
 35201-18 18 cm, 7"

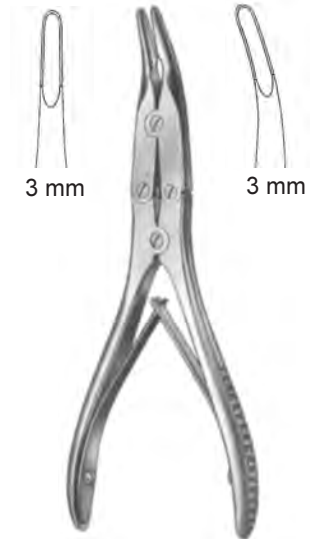

BÖHLER
 35211-15 15 cm, 6" 35213-15

Knochensplitterzangen
Bone Cutting Forceps
Pinzas cortantes para huesos
Cesoie per ossa



BÖHLER
35280-15 15 cm, 6"



BÖHLER
35281-15 15 cm, 6"



COTTLE-KAZANJIAN
35282-19 19 cm, 7 1/2"



MC INDOE
35283-17 17 cm, 6 3/4"

— MT- Braun Instrumente

Hämmer
Bone Mallets
Martillos
Martelli

Ø 25 mm



GERZOG
35686-25
18 cm, 7" 250g

Ø 25 mm



35694-01 18,5 cm, 7 1/4", 135 g
35694-03 Ersatzbacken
Nylon Caps
Tapas de repuesto
Placche di ricambio

Ø 25 mm



35694-02 18,5 cm, 7 1/4"
mit Nylonbacke
with nylon tap
con tapa de nylon
con placca di nylon

Ø 20 mm



MEAD
35693-32
17 cm, 6 3/4" 320 g

Ø 22 mm



PARTSCH
35698-98
18 cm, 7" 199 g



QUISLING
35696-75
17 cm, 6 3/4"

Ø 30 mm



COTTLE
35700-05
18 cm, 7" 240 g

Elevatoren, Raspatoren
Elevators, Raspatories
Elevadores, Legras
Elevatori, Periostotomi



LANGENBECK
20 cm, 8"
35711-20 8 mm
35711-21 10 mm



4 mm

WILLIGER
16 cm, 6 1/4"
35711-16



6,5 mm

WILLIGER
16 cm, 6 1/4"
35712-16



5,5 mm

WILLIGER
35713-17
16 cm, 6 1/4"



4 mm

JOSEPH
35718-16
16 cm, 6 1/4"



4 mm

FOMON
35719-17
16 cm, 6 1/4"

—MT- Braun Instrumente—

Elevatoren, Raspatoren
Elevators, Raspatories
Elevadores, Legras El-
evatori, Periostotomi

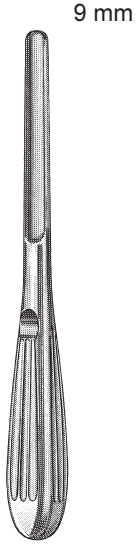

BOIES
35720-19
19 cm, 7 1/2"



GORNEY
35720-21
21 cm, 8 1/4"



McKENY
15 cm, 6"

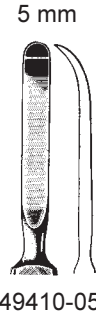

JOSEPH
49411-16
16 cm, 6 1/4"



MASIG
49414-21
22 cm, 8 3/4"

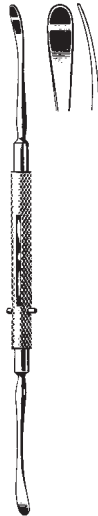

FREER
49415-18
18 cm, 7"

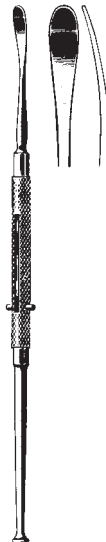

FREER
49417-19
19 cm, 7 1/2"

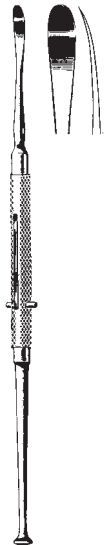

FREER
49419-19
19 cm, 7 1/2"

MT- Braun Instrumente

Elevatoren, Raspatoren
Elevators, Raspatories
Elevadores, Legras
Elevatori, Periostotomi



KILLIAN
49420-01
18,5 cm, 7¹/₄"



PIERCE
49420-02
21 cm, 8¹/₄"



SINUS
49420-03
18 cm, 7"



PENNINGTON
49420-04 21
cm, 8¹/₄"



McKENTY
49420-20
22 cm, 8³/₄"

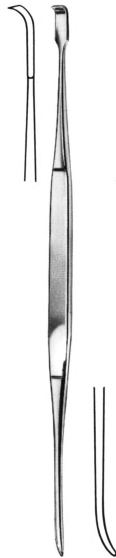

HOWARTH
49421-21
21,5 cm, 8¹/₂"



COTTLE
49421-23
23 cm, 9"



COTTLE JOSEPH
49422-22
22 cm, 8³/₄"

—MT- Braun Instrumente

Elevatoren, Raspatoren
 Elevators, Raspatories
 Elevadores, Legras
 Elevatori, Periostotomi



COTTLE
 49423-22 22 cm, 8³/₄"



COTTLE
 49424-16 16 cm, 6¹/₄"



COTTLE
 49425-19 19 cm, 7¹/₂"



KILLIAN
 49426-22 22 cm, 8³/₄"



HAJEK-BALLENGER
 49428-21 22 cm, 8³/₄"



BALLENGER
 49430-22 22 cm, 8³/₄"

Lippen- und Gaumenspaltinstrumente
Lip and Cleft Palate Instruments
Instrumentos para labios y fisura palatina
Strumenti per labbra e fessure del palato

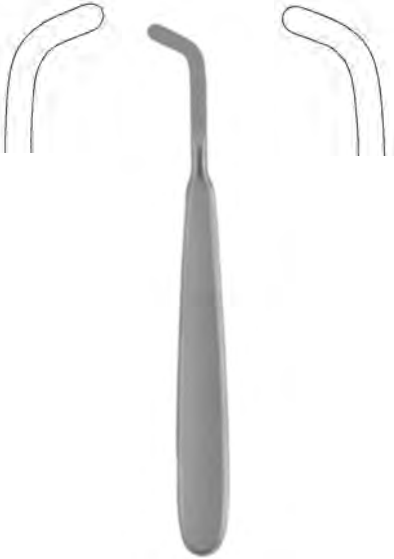

51278-01 14 cm, 5½" 51278-02



CRIONIN 51280-18
18 cm, 7"

—MT- Braun Instrumente

Lippen- und Gaumenspaltinstrumente
Lip and Cleft Palate Instruments
Instrumentos para labios y fisura palatina
Strumenti per labbra e fessure del palato



BLAIR
51281-01
23 cm , 9"



BLAIR
51281-02
20 cm, 8"

Saugkanülen
Suction Tubes
Tubos de aspiracion
Cannula aspirante



ADSON
43290-21
20 cm, 8¹/₄"
Ø 4 mm



BARON
43299-03 3FR Ø 1,0 mm
43299-05 5FR Ø 1,6 mm
43299-07 7FR Ø 2,3 mm

Arbeitslänge
working length
largo útil
lunghezza utile
75 mm

Saugkanülen
Suction Tubes
Tubos de aspiracion
Cannula aspirante



FRAZIER/FERGUSSON
19 cm, 7½"

Charr.

F.G.	Ø	30°	75°
6	2,0 mm	43295-06	43297-06
7	2,3 mm	43295-07	43297-07
8	2,7 mm	43295-08	43297-08
9	3,0 mm	43295-09	43297-09
10	3,3 mm	43295-10	43297-10
11	3,6 mm	43295-11	43297-11
12	4,0 mm	43295-12	43297-12

Saugkanülen
Suction Tubes
Tubos de aspiracion
Cannula aspirante

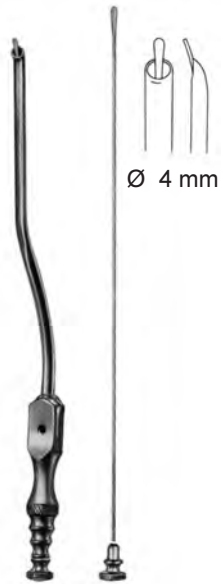

GUILLEN
49347-20
19 cm, 7½"
Ø 4 mm

Nasenspekula
Nasal Speculum
Espéculos nasales
Specoli nasali



HARTMANN-HALLE
15 cm, 6"

28 mm

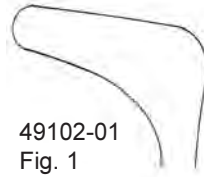

49102-01
Fig. 1

30 mm



49102-02
Fig. 2

32 mm

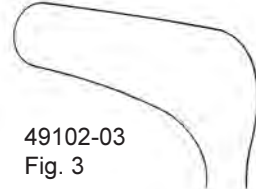

49102-03
Fig. 3

Nasenspekula
Nasal Speculum
Espéculos nasales
Specoli nasali



HARTMANN
16 cm, 6 1/4"

30 mm

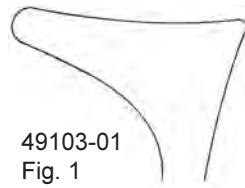

49103-01
Fig. 1

33 mm



49103-02
Fig. 2

35 mm

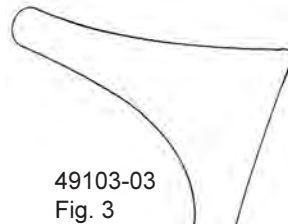

49103-03
Fig. 3

MT- Braun Instrumente

Nasenspekula
 Nasal Speculum
 Espéculos nasales
 Specoli nasali



Mod. WIEN
 14 cm, 5 1/2"

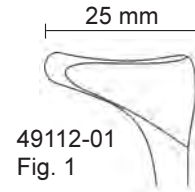

Baby, bebé, neonato

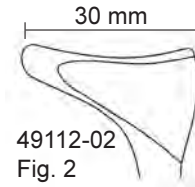

Kind, child, niño, bambino

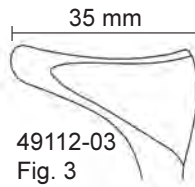

Erwachsene, Adult, adulto



TIECK-HALLE
 49116-13
 13,5 cm, 5 1/4"



MT-BRAUN INSTRUMENTE
 49118-13
 12,5 cm, 5"

Nasenspekula
Nasal Specula
Espéculos nasales
Specoli nasali



KILLIAN
13 cm, 5 1/8"

35 mm

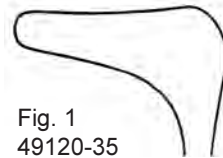

Fig. 1
49120-35

50 mm



Fig. 2
49120-50

75 mm

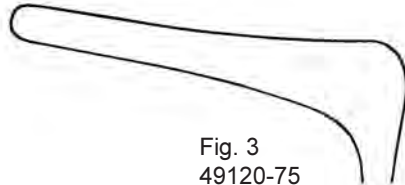

Fig. 3
49120-75

90 mm

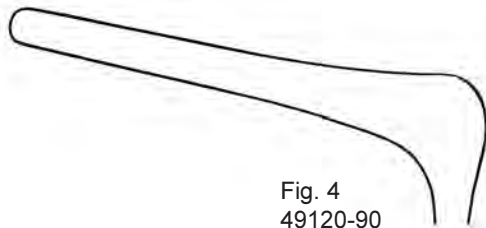

Fig. 4
49120-90

MT- Braun Instrumente

Nasenspekula
Nasal Specula
Espéculos nasales
Specoli nasali



KILLIAN
13 cm, 5¹/₈"

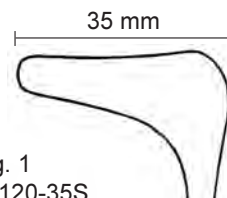

Fig. 1
49120-35S

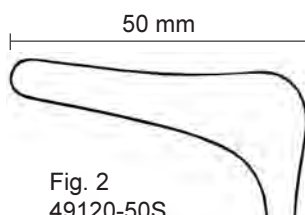

Fig. 2
49120-50S



Fig. 3
49120-75S

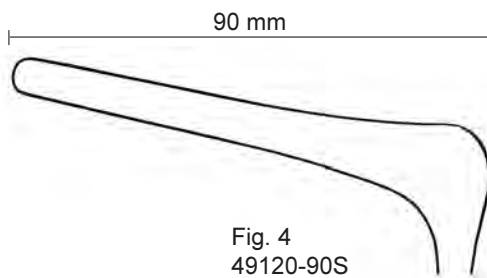
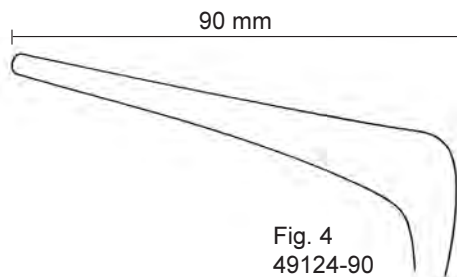
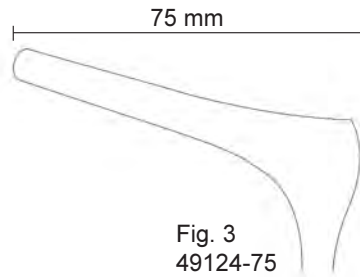
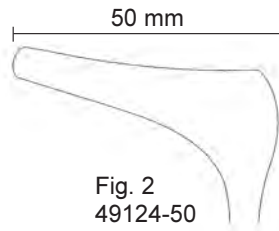
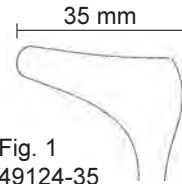

Fig. 4
49120-90S

Nasenspekula
Nasal Speculum
Espéculos nasales
Specoli nasali



COTTLE
14 cm, 5½"



Nasenspekula
Nasal Speculum
Espéculos nasales
Specoli nasali



COTTLE
14 cm, 5 1/2"

35 mm

Fig. 1
49124-35S

50 mm

Fig. 2
49124-50S

75 mm

Fig. 3
49124-75S

90 mm

Fig. 4
49124-90S

MT- Braun Instrumente

Nasentamponzange, Polypenzange
Nasal Tampon Forceps, Ear Polypus Forceps
Pinza para taponamiento, Pinzas para pólipos
Pinze per medicature, Pinze per polipi



WESTMACOTT
49158-20 20 cm, 8"



LUBET-BARBON
49159-20 20 cm, 8"



HARTMANN
49161-16 16 cm, 6 1/4"



HARTMANN
49161-20 20 cm, 8"

—MT- Braun Instrumente

Polypenzangen, Septumzangen
Nasal Polypus and Septum Forceps
Pinzas para pólipos y para el tabique nasal
Pinze per polipi, Pinze per il setto nasale



HEYMANN-KNIGHT
49169-18
18 cm, 7"



KNIGHT
49185-18
18 cm, 7"

Septumzangen
Septum Forceps
Pinzas para el tabique nasal
Pinze per il setto nasale

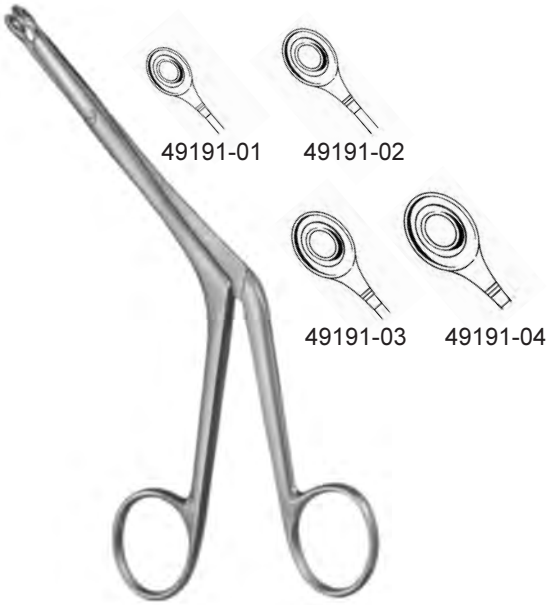

BRUENINGS
19 cm, 7 1/2"

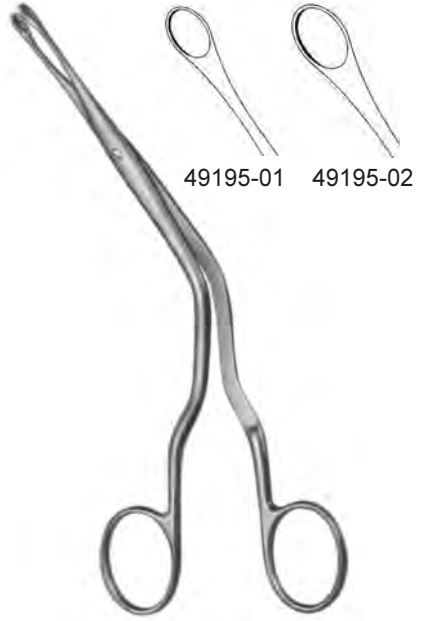

LUC
19 cm, 7 1/2"



GRAIG
49192-16 16 cm, 6 1/2"

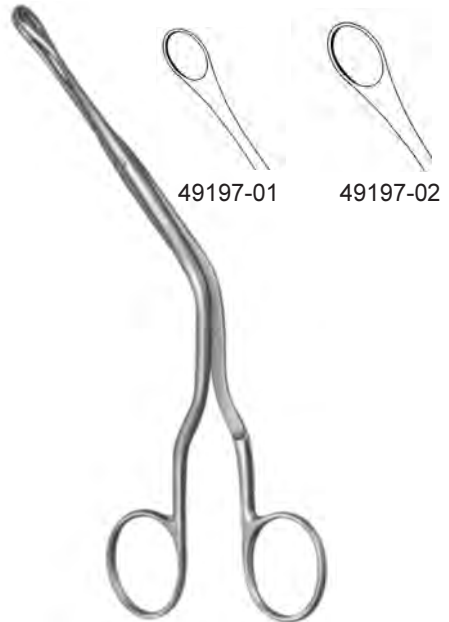

LUC
19 cm, 7 1/2"

Scharfe Nasenzange
 Nasal Cutting Forceps
 Pinzas cortantes nasales
 Pinze taglianti nasali

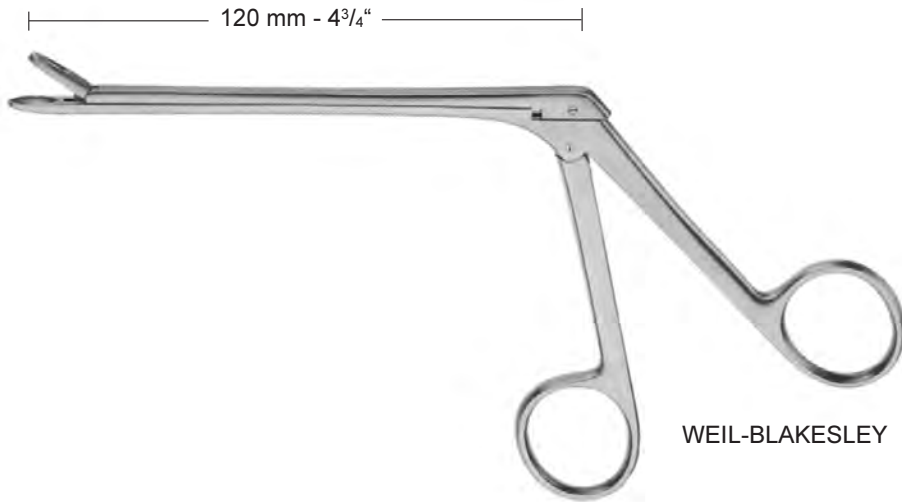
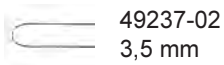
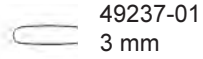

	Fig.1	Fig. 2	Fig.3	Fig.4	Fig. 5
	49223-01 3,0 mm	49223-02 3,6 mm	49223-03 4,2 mm	49223-04 4,8 mm	49223-05 5,8 mm
	49224-01 3,0 mm	49224-02 3,6 mm	49224-03 4,2 mm	49224-04 4,8 mm	49224-05 5,8 mm
	49225-01 3,0 mm	49225-02 3,6 mm	49225-03 4,2 mm	49225-04 4,8 mm	
	49226-01 2,0 mm	49226-02 2,5 mm	49226-03 3,0 mm		
	49227-01 2,0 mm	49227-02 2,5 mm	49227-03 3,0 mm		

Scharfe Nasenzangen
Nasal Cutting Forceps
Pinzas cortantes nasales
Pinze taglienti nasali



49239-01

49239-02



MYLES



SCHMEDEN



TAKAHASHI



49242-00



49242-01

—MT- Braun Instrumente

Septumzange, Scharfe Nasenzange
Septum Forcep, Nasal Cutting Forceps
Pinza para el tabique nasal, Pinza cortante nasal
Pinza per setto nasale, pinze taglienti nasali



RUBIN
49251-21
21 cm, 8¹/₄"



CAPLAN
49256-20
20 cm, 8"

Septumzangen
Septum Forceps
Pinzas para el tabique nasal
Pinze per il setto nasale



MIDDLETON-JANSEN
49323-19
19 cm, 7½"



MIDDLETON-JANSEN
49325-19
19 cm, 7½"

MT- Braun Instrumente

Rhinoplastikmesser
 Rhinoplasty knives
 Cuchillos nasales
 bisturi nasale

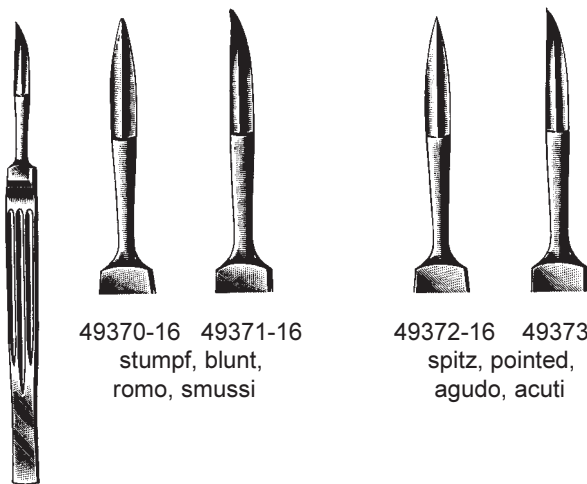

49370-16 49371-16
 stumpf, blunt,
 romo, smussi

49372-16 49373-16
 spitz, pointed,
 agudo, acuti

JOSEPH
 16 cm, 6 $\frac{1}{4}$ "



FREER
 49374 - 16
 16,5 cm, 6 $\frac{1}{2}$ "



JOSEPH
 49375 - 16
 16 cm, 6 $\frac{1}{4}$ "



FREER
 49375 - 19
 19 cm, 7 $\frac{1}{2}$ "

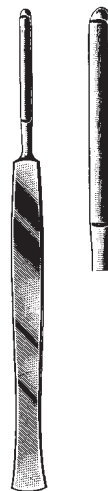

JOSEPH
 49376 - 16
 16 cm, 6 $\frac{1}{4}$ "

Rhinoplastikmesser
Rhinoplasty knives
Cuchillos nasales
bisturi nasale

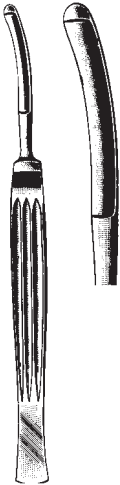

CONVERSE
49379 - 16
16 cm, 6 1/4"



COTTLE
49380-15
15 cm, 6"



COTTLE
49382-15
15 cm, 6"



JOSEPH
49384-15
15 cm, 6"



JOSEPH
49385-15
15 cm, 6"



MT-BRAUN INSTRUMENTE 19 cm 7 1/2"



49386-01
spitz
pointed
agudo
acuto



49386-02
stumpf
blunt
romo
smusso

MT- Braun Instrumente

Schwingmesser
Septum Swivel Knives
Cuchillos para el tabique nasal
Coltelli per setto



BALLENGER
49390-03 - 49392-05
20 cm, 8"



49390-03
3 mm



49390-04
4 mm



49390-05
5 mm



49392-03
3 mm



49392-04
4 mm



49392-05
5 mm



Kapselmesser
Capsulotorz knife
Cuchillo para capsula
Cotello per capsula



FOERSTER
49394-27 27 cm, 10 $\frac{1}{2}$ "

— MT- Braun Instrumente

Septum Elevatoren
Septum Elevators
Elevadores para el tabique
Elevatori per setto



FREER
49450-04
15 cm, 6"



FREER
49451-04
15 cm, 6"



REES
49453-03
18,5 cm, 7 1/4"

Aluminiumgriff
Aluminium handle
Mango de aluminio
Manico in alluminio

Septum Meißel, Osteotome
 Rhinoplastic Chisels, Osteotomes
 Cinceles para la plástica nasal, Osteotomos
 Scalpelli per plastica nasale, Osteotomi

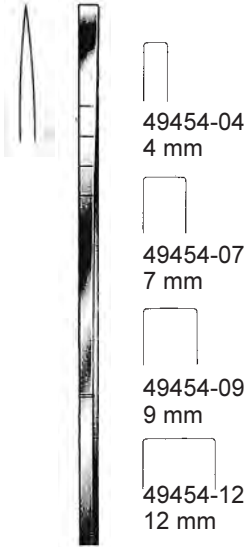

COTTLE
18 cm, 7"



COTTLE
49455-06
18 cm, 7"

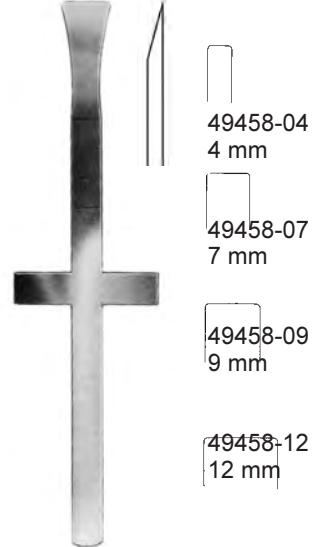

COTTLE
18 cm, 7"

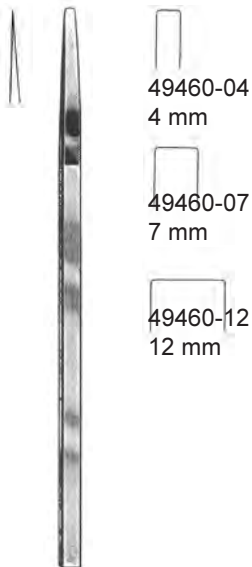

COTTLE
18 cm, 7"

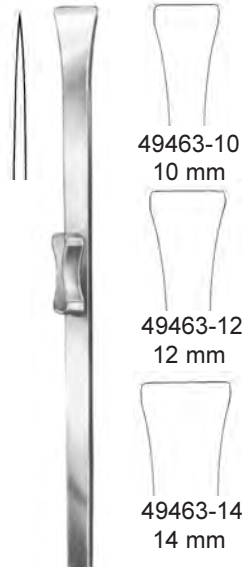

RUBIN
18,5 cm, 7 1/4"

MT- Braun Instrumente

Osteotome, Septum Meißel
 Osteotomes, Rhinoplastic Chisels
 Osteotomo, Cinceles para la plástica nasal
 Osteotomi, Scalpelli per plastica nasale

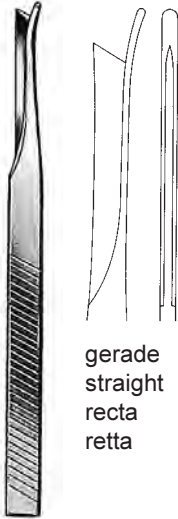

gerade
 straight
 recta
 retta

SILVER
 49473-01
 18 cm, 7"

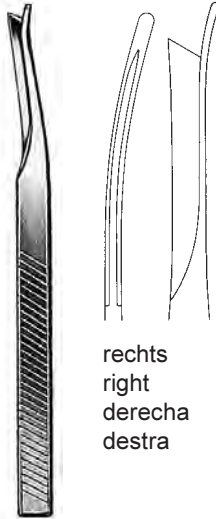

rechts
 right
 derecha
 destra

SILVER
 49473-02
 18 cm, 7"

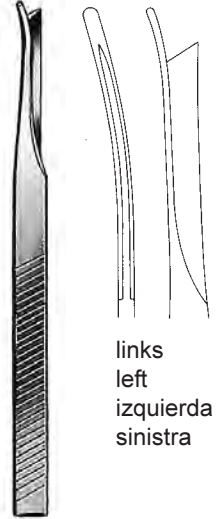

links
 left
 izquierda
 sinistra

SILVER
 49473-03
 18 cm, 7"



49474-01
 rechts
 right
 derecha
 destra

NEIVERT-ANDERSON
 20,5 cm, 8" 7 mm

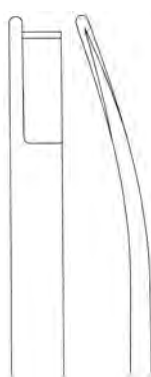

49474-02
 links
 left
 izquierda
 sinistra

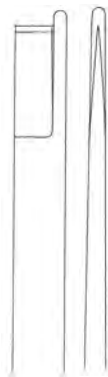

49474-03
 gerade
 straight
 recta
 retta



KILLIAN
 49481-05 16 cm, 6 1/4"

Osteotome
Osteotomes
Osteotomo
Osteotomi



49475-04
49475-06
49475-08

4 mm
6 mm
8 mm

OBWEGESER
18,5 cm, 7 1/4"

MT- Braun Instrumente

Septum Meißel, Osteotome, Hohlmeißel
 Rhinoplastic Chisels, Osteotomes, Gouges
 Cinceles para la plástica nasal, Osteotomos, Gubias
 Scalpelli per plastica nasale, Osteotomi, Sgorbie



KILLIAN-CLAUS
 49482-05
 17 cm, 6³/₄"



HAJEK
 49484-04 4 mm
 49484-06 6 mm
 49484-08 8 mm
 16 cm, 6¹/₄"



WEST
 49486-16
 16 cm, 6¹/₄"



WEST
 49487-16
 16 cm, 6¹/₄"



FREER
 49489-16
 16 cm, 6¹/₄"



2 mm



3 mm



4 mm



5 mm



6 mm



8 mm



10 mm



12 mm



15 mm

12,5 cm, 5"

mm

17 cm, 6³/₄"

35654-02

2

35652-02

35654-03

3

35652-03

35654-04

4

35652-04

35654-05

5

35652-05

35654-06

6

35652-06

35654-08

8

35652-08

35654-10

10

35652-10

35654-12

12

35652-12

35654-15

15

35652-15

MINI-LAMBOTTE

Knorpelquetscher
Cartilage crusher
Macha cadera
Tritacartilagine



COTTLE
49461-00 7,5 cm, 3"

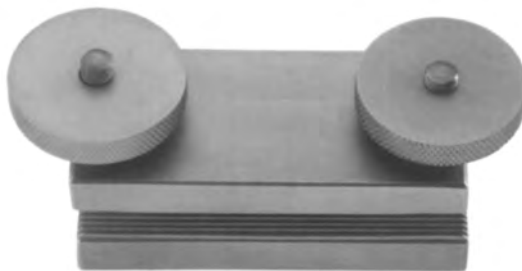

JOST
49462-00

—MT- Braun Instrumente

Nasenraspeln
 Nasal Rasps
 Escofinas nasales
 Raspa nasale



JOSEPH
 49502-16 16 cm, 6 1/4"



MALTZ
 49504-18 18 cm, 7"

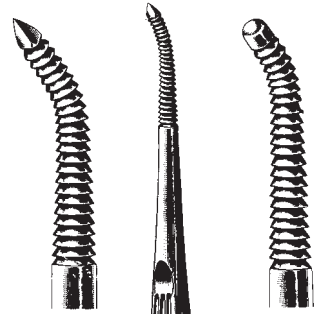

49507-17

49507-18

WIENER
 18 cm, 7"



diamantiert
 with diamond coating
 con boca de diamante
 diamantata

PEET
 49523-01 19 cm 7 1/2" 49523-02



GLABELLA
 49524-01 21 cm, 8 1/4"



49525-20
 fein, fine, fino, fina
 20 Zähne
 20 teeth
 20 dientes
 20 denti

49526-20
 grob, coarse, gruesa, grossa
 11 Zähne
 11 teeth
 11 dientes
 11 denti

PARKES
 49525-20 21 cm, 8 1/4"

Nasenraspeln
Nasal Rasps
Escofinas nasales
Raspa nasale

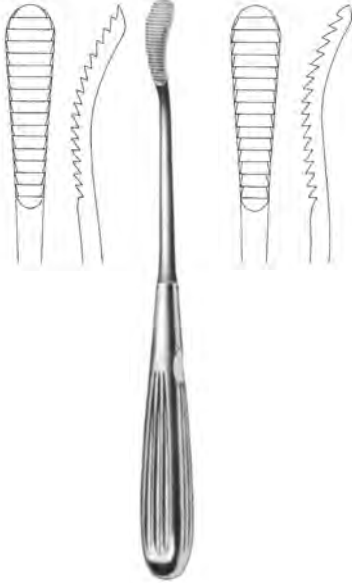

AUFRICHT
49511-21 21 cm, 8 1/4" 49513-21

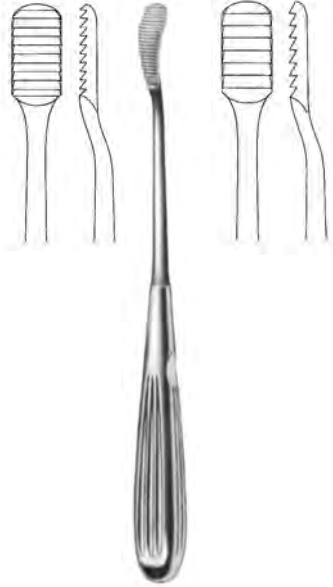

JOSEPH (LEWIS)
49514-16 18 cm, 7" 49516-16

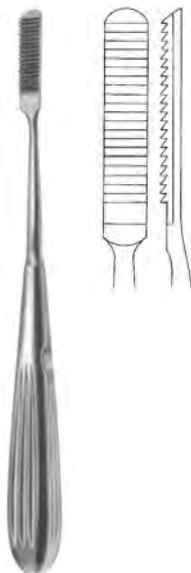

MALTZ (COTTLE)
49518-21 21 cm, 8 1/4"

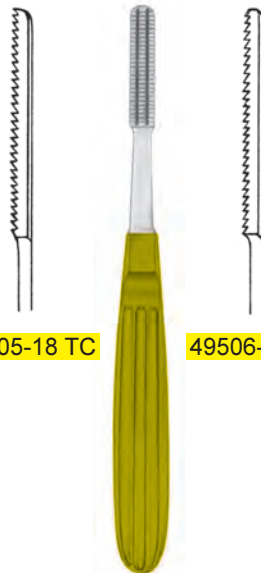

49505-18 TC

49506-18 TC

MALTZ
17,5 cm, 6.9"

MT- Braun Instrumente

Nasenraspeln
Nasal Rasps
Escofinas nasales
Raspa nasale

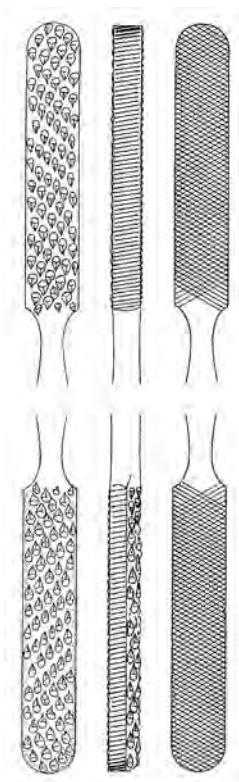

FOMON
49520-21
21 cm, 8¹/₄"

Nasenraspeln
Nasal Rasps
Escofinas nasales
Raspa nasale

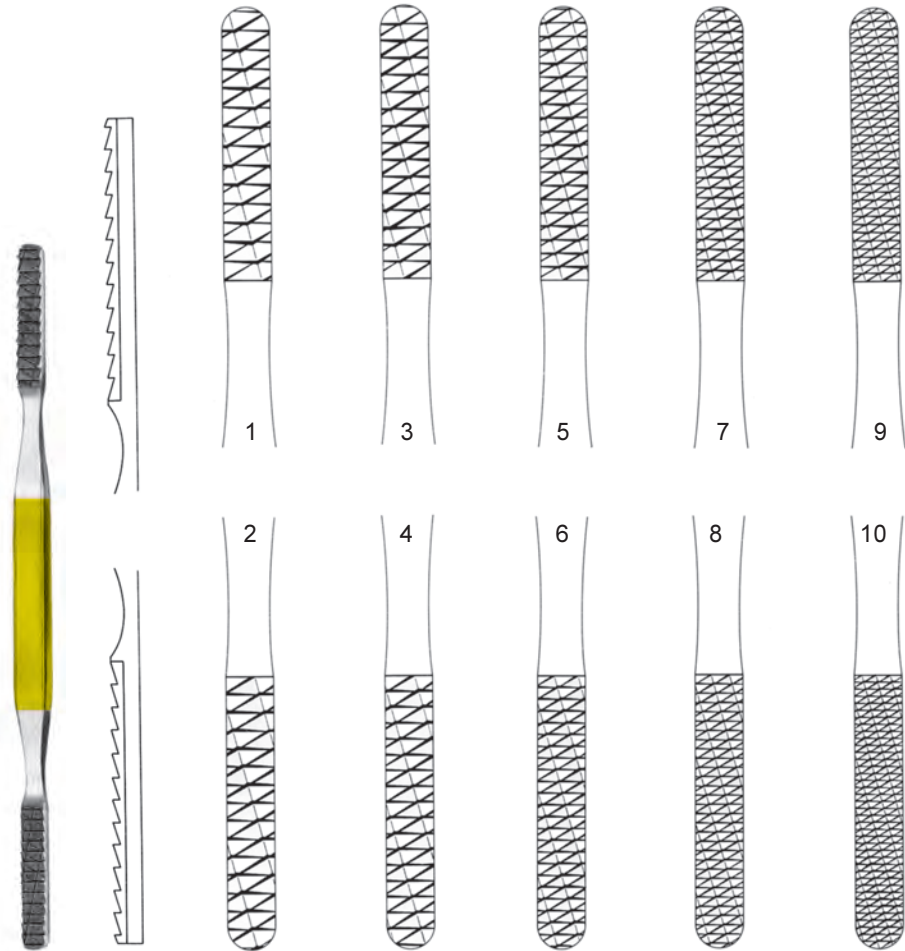

FOMON

49522-01TC - 49522-09 TC

20 cm, 8"

Fig. 1/2

49522-01 TC

Fig. 3/4

49522-04 TC

Fig. 5/6

49522-05 TC

Fig. 7/8

49522-07 TC

Fig. 9/10

49522-09 TC

—MT- Braun Instrumente

Nasenraspeln, Nasensägen
 Nasal Rasps, Nasal Saws
 Escofinas nasales, Sierras nasales
 Raspa nasale, Seghe nasale

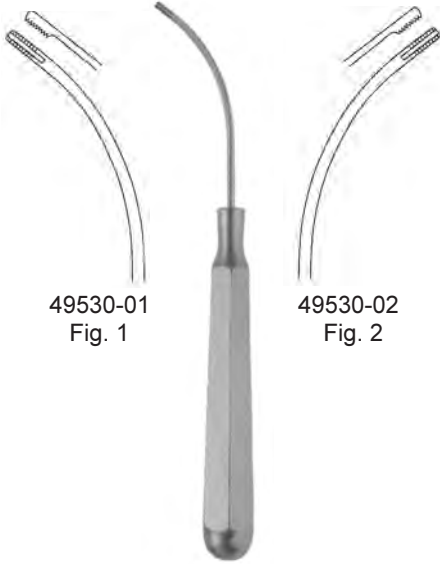

49530-01
Fig. 1

49530-02
Fig. 2

DINGMAN Set
49530-00 15 cm, 6"



Drahtbürste zum Reinigen von Raspeln
 Wirebrush for cleaning the rasps
 Cepillo de alambre para limpiar las escofinas
 Spazzolino di fili metallici per pulire le raspe

49531-00 16 cm, 6 1/4"

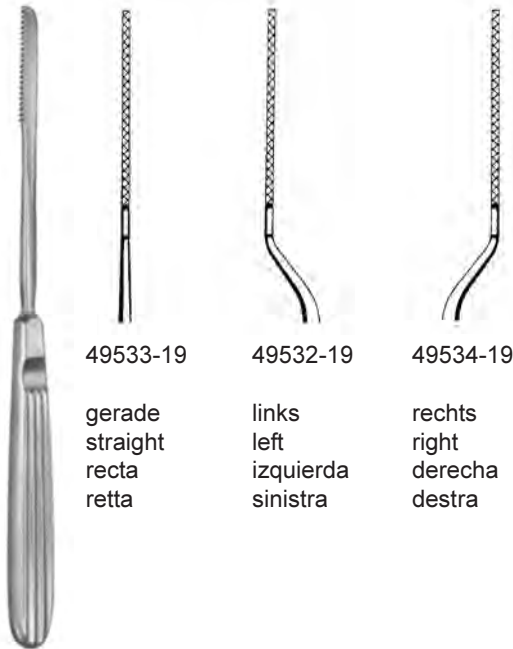

49533-19

gerade
straight
recta
retta

49532-19

links
left
izquierda
sinistra

49534-19

rechts
right
derecha
destra

JOSEPH
19 cm, 7 1/2"

Nasensägen
Nasal Saws
Sierras nasales
Seghe nasale



JOSEPH
49535-01 17 cm, 6³/₄" 49535-02

MT- Braun Instrumente

Septumrichtzangen
Septum Straightening Forceps
Pinza para enderezar el tabique nasal
Pinza per la plastica nasale



ASCH
49571-23
23 cm, 9"



WALSHAM
49572-23
23 cm, 9"

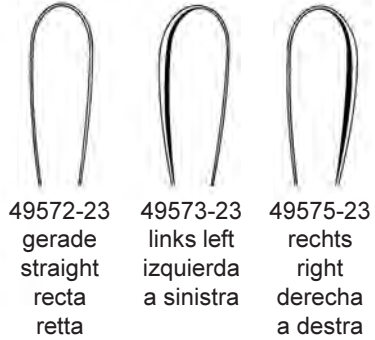

49572-23
gerade
straight
recta
retta

49573-23
links left
izquierda
a sinistra

49575-23
rechts
right
derecha
a destra

MT- Braun Instrumente

Zungendrucker, Mundsperrer
Tongue Depressors, Mouth Gags
Boja-lengua, Abre-Bocas
Abbassalingua, Apribocca



WIEDER



51115-01
Fig. 1 14
cm, 5 1/2"



51115-02
Fig. 2 15
cm, 6"



ANDREW
49117-11
11 cm, 4 3/8"

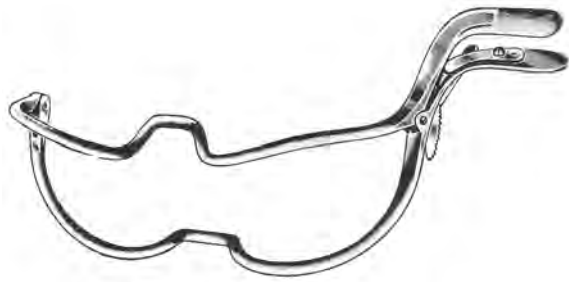

JENNINGS
51274-09 9 cm, 3 1/2"
51274-11 11 cm, 4 3/8"
51274-13 13 cm, 5 1/8"
51274-15 15 cm, 6"

MT- Braun Instrumente

Mundsperrer
 Mouth Gags
 Abre-Bocas
 Apribocca

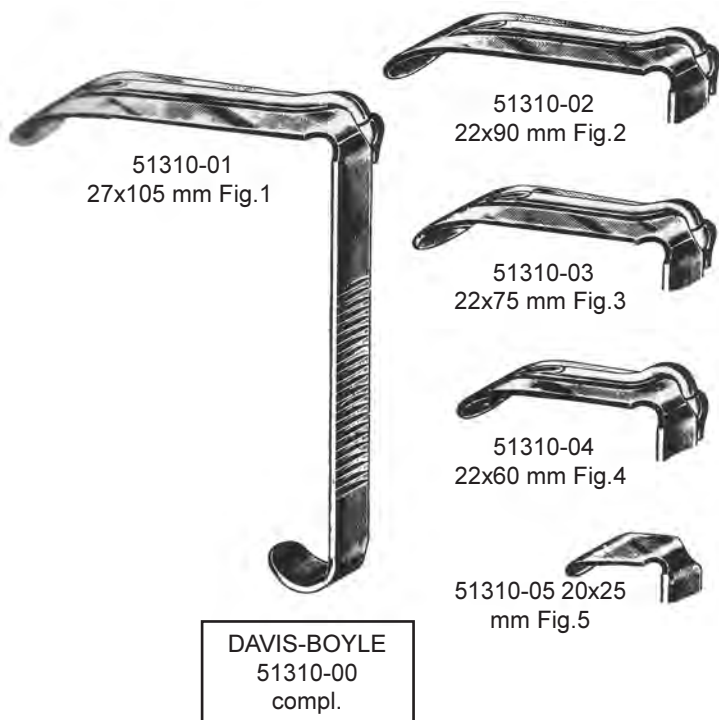

51310-01
 27x105 mm Fig.1

51310-02
 22x90 mm Fig.2

51310-03
 22x75 mm Fig.3

51310-04
 22x60 mm Fig.4

51310-05 20x25
 mm Fig.5

DAVIS-BOYLE
 51310-00
 compl.



Sperrer allein
 Gag only Abre-
 boca suelto
 Apribocca solo

DAVIS-BOYLE

	für Erwachsene for adults para adultos per adulti	für Kinder for children para niños per bambini
links left izquierda sinistra	51310-10	51310-11
rechts right derecha destra	51310-12	51310-09

Mundsperrer
 Mouth Gags
 Abre-Bocas
 Apribocca



51315-10 Sperrer allein
 Gag only
 Abre-boca
 suelto
 Apribocca solo



51315-01
 Fig.1



51315-02
 Fig.1



51315-03
 Fig.1

KILNER-DOUGHTY
 51315-00 compl.

51317- 00 DINGMANN, komplett
 mit 3 auswechselbaren Zungendrucker,
 2 seitliche Wangenhaken und 2 Zahnhaken

with 3 interchangeable tongue depressors,
 2 rotating cheek holders,
 2 movable tooth hooks and thread guide

con 3 baja lenguas intercambiables
 2 valvas giratorias p. los labios
 2 ganchos graduables

con 3 depressori intercambiabili,
 2 valve laterali rotative,
 2 uncini a denti mobile

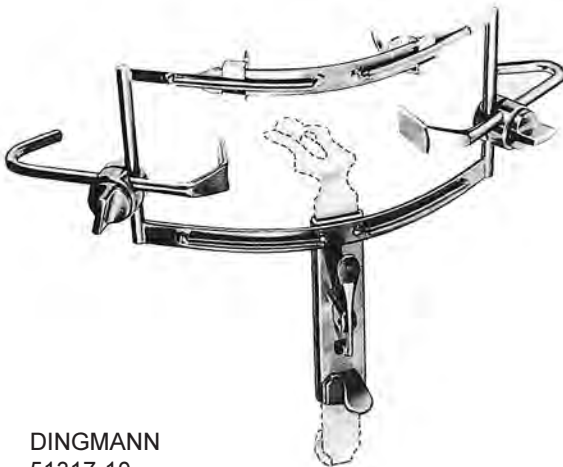

DINGMANN
 51317-10
 Sperrer allein, Gag only
 Abre-boca suelto, Apribocca solo



1 24x62 mm
 51317-01



2 28x65 mm
 51317-02



3 31x75 mm
 51317-03

MT- Braun Instrumente

Mundsperrer, Zungenspatel
Mouth Gags, Tongue depressor
Abre-Bocas, Baja-lengua
Apribocca, Abbassalingua

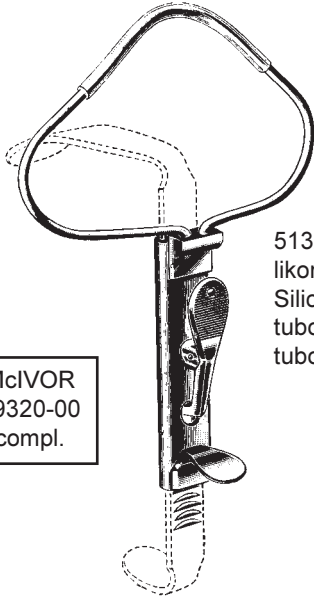

51320-10

51320-20 Si-
likon-Schlauch
Silicon Tubing
tubo de silicona
tubo in silicone

McIVOR
49320-00
compl.

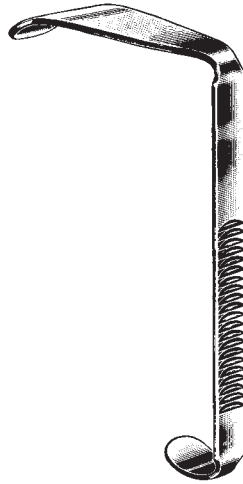

51320-01
27x95 mm Fig.1



51320-02
22x85 mm Fig.2

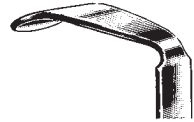

51320-03
22x75 mm Fig.3



DAVIS-MEYER
51340-00

Zungenspatel
Tongue blades
Baja-lenguas
Abbassalingua



RUSSEL-DAVIS

—MT- Braun Instrumente

Wundhaken für Mund-Kiefer-Gesicht
Retractors, Raspatories for Mouth-, Jaw- and Face Surgery
Separadores para cirugía de boca -mandíbula- fiscal
Divaricatori, Periostotomi per bocca, mascella, viso



OBWEGESER
22 cm, 8³/₄"



51605-07 25x7 mm

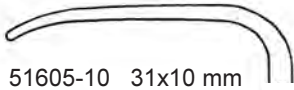

51605-10 31x10 mm



51605-11 42x11 mm



51605-12 55x12 mm



51605-14 70x14 mm



51605-16 80x16 mm

Wundhaken für Mund-Kiefer-Gesicht
Retractors, Raspatories for Mouth-, Jaw- and Face Surgery
Separadores para cirugía de boca -mandíbula- facial
Divaricatori, Periostotomi per bocca, mascella, viso



OBWEGESER
22 cm, 8³/₄"

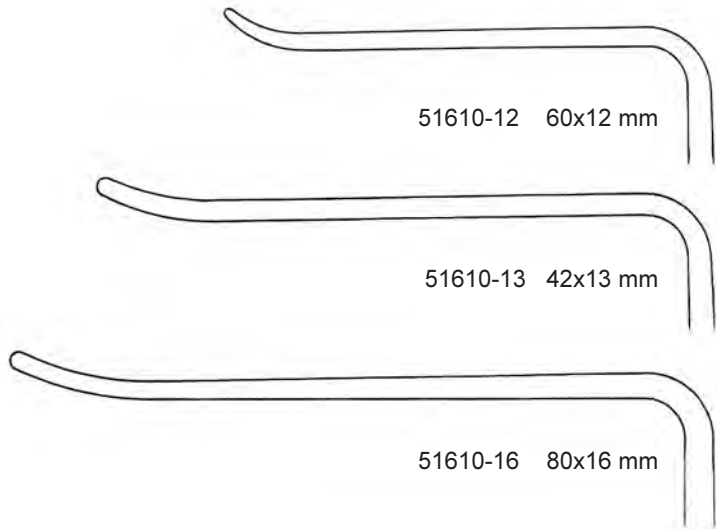

51610-12 60x12 mm

51610-13 42x13 mm

51610-16 80x16 mm

MT- Braun Instrumente

Wundhaken für Mund-Kiefer-Gesicht
 Retractors, Raspatories for Mouth-, Jaw- and Face Surgery
 Separadores para cirugía de boca- mandíbula- fiscal
 Divaricatori, per bocca, mascella, viso

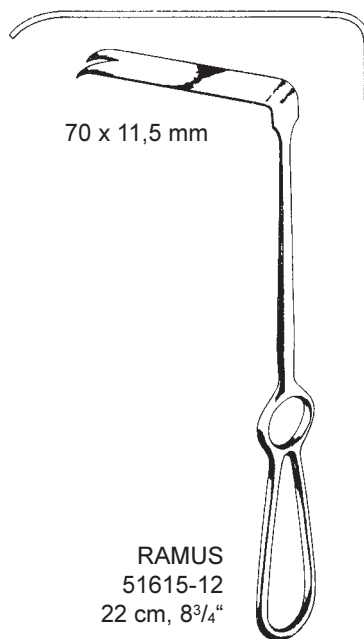
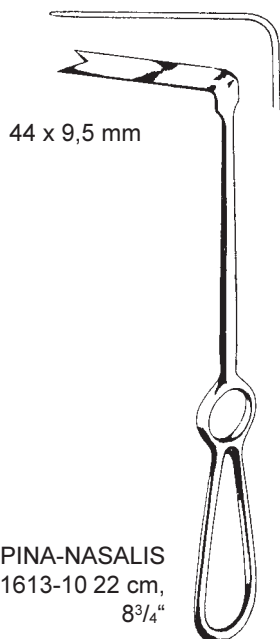

OBWEGESER
 51620-15 15,5
 cm, 6"

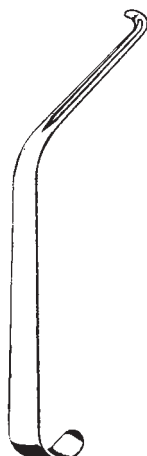

OBWEGESER
 51623-16 16
 cm, 6¹/₄"



OBWEGESER
 51627-01 21
 cm, 8¹/₄"



OBWEGESER
 51630-02 20,5
 cm, 8"

Raspatorien, Elevatoren
Periosteal Elevators
Legras
Periostotomi

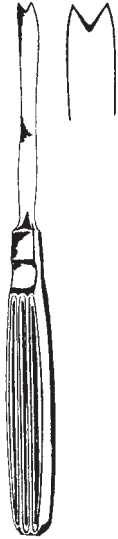

OBWEGESER
51635-18 17,5 cm, 7"



OBWEGESER
20 cm, 8"

5 mm



51640-05

7mm



51640-07

9 mm



51640-09



OBWEGESER
17,5 cm, 7"

6 mm



51650-06

7 mm



51650-07

9 mm



51650-09

11 mm



51650-11

MT- Braun Instrumente

Raspator, Wundhaken, Elevator
 Raspatories, Retractor, Elevators
 Legras, Separadores, Elevadores
 Periostotomo, Divaricatore, Elevatore

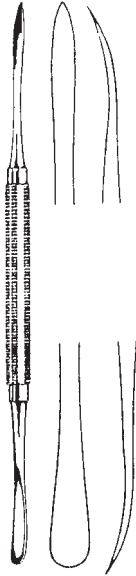

DINGMAN
 51660-18 18 cm, 7"



19 cm, 7 1/2"

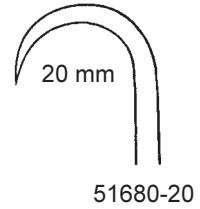
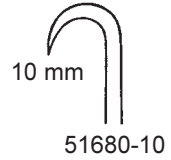

DINGMAN
 51685-21 21 cm, 8 1/4"

links left izquierda
 rechts right derecha



TESSIER
 51691-15 15 cm, 6"

TESSIER
 51692-15 15 cm, 6"

Osteotome
Osteotome
Osteótomos
Osteotomi



51666-10 10 mm
51666-15 15 mm
51666-20 20 mm

TESSIER
20,5 cm 8"



51667-10 10 mm
51667-15 15 mm

TESSIER
20,5 cm 8"



7 mm

51700-01
21,5 cm, 8 1/2"



10 mm

51700-02
21,5 cm, 8 1/2"

MT- Braun Instrumente

Endoskopische Instrumente
 Endoscopic Instruments
 Instrumentos para endoscopia
 Strumenti endoscopici

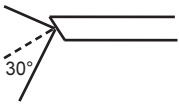
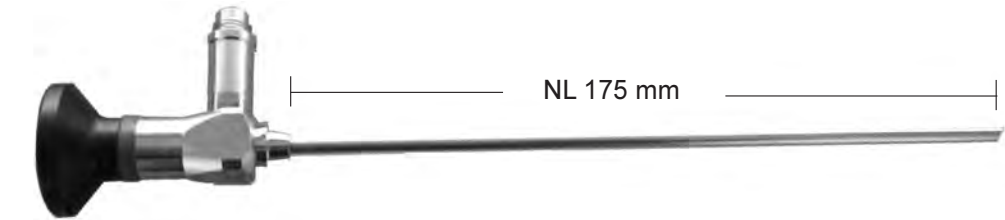

Vorausblick	30°	R602-050175-030
Foroblique vision	30°	
Visión hacia adelante	30°	
Grandangolo, visione	30°	

Endoskop für plastische Chirurgie 5 mm Ø, 30° Blickrichtung, 175 mm Nutzlänge, autoklavierbar, integrierte Faser für Ausleuchtung

Endo-Plastic-Scope 5mm Ø, 30° direction of view, 175 mm working length, autoclavable, integrated fiberoptic bundle for illumination

Optica para endoplastia de 5 mm Ø, vision de 30°, largo útil de 175 mm, autoclavable, con fibra-optica para la iluminación

Ottica per endoplastica 5 mm Ø, visione 30°, lunghezza utile 175 mm, autoclavabile con fibre ottiche per illuminazione

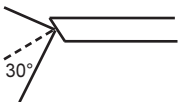
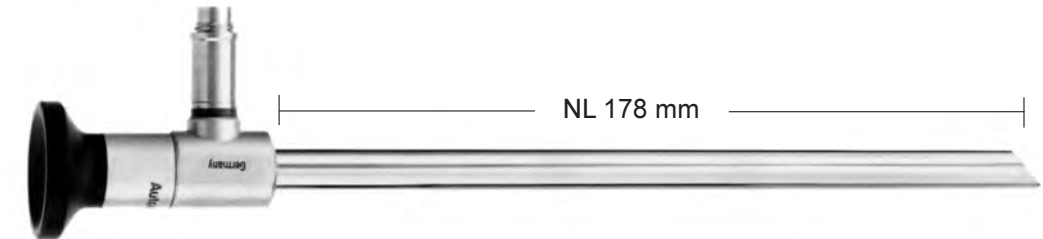

Vorausblick	30°	R602-100178-030
Foroblique vision	30	
Visión hacia adelante	30°	
Grandangolo, visione	30°	

Endo-Plastik-Optik 10 mm Ø, 30° Blickrichtung, 178 mm Nutzlänge, autoklavierbar, integrierte Fiberoptik für Ausleuchtung

Endo-Plastic-Scope 10 mm Ø, 30° direction of view, 178 mm working length, autoclavable, integrated fiberoptic bundle for illumination

Optica para endoplastia de 10 mm Ø, vision de 30°, largo útil de 178 mm, autoclavable, con fibra-optica para la iluminación

Ottica per endoplastica 5 mm Ø, visione 30°, lunghezza utile 178 mm, autoclavabile con fibre ottiche per illuminazione



Schaft für Plastische Chirurgie mit 1 Hahn, drehbar, passend für 5 mm Optik mit 175 mm Nutzlänge

Endo-Plastic Sheath with spatula, 1 stopcock rotatable, for 5 mm scope with 175 mm work. length

Camisa para cirugía plástica, una llave giratoria, para óptica de 5 mm, largo útil de 175 mm

Camicia per chirurgia plastica, con spatola, 1 rubinetto rotante, per ottica 5 mm, lunghezza 175 mm

7x17 mm gefenstert / 7x17 mm fenestrated
7x17 mm fenestrada / 7x17 mm fenestrata

R612-050175-070

11x17 mm gefenstert / 11x17 mm fenestrated
11x17 mm fenestrada / 11x17 mm fenestrata

R612-050175-110

11x23 mm gefenstert / 11x23 mm fenestrated

Endoskopische Instrumente
Endoscopic Instruments
Instrumentos para endoscopia
Strumenti endoscopici



R612-050175-001

Schaft für Plastische Chirurgie, schnabelförmig, breit/flach, 1 Hahn, drehbar, passend für 5 mm Optik mit 175 mm Nutzlänge

Endo-Plastic Sheath with oblique beak wide/flat, 1 stopcock rotatable, suitable f. 5 mm scope with 175 mm working length

Camisa para cirugía plástica en forma de pico, ancho y plano, con una llave giratoria, para óptica de 5 mm, largo útil de 175 mm

Camicia per chirurgia plastica, a forma di becco, larga/piatta, 1 rubinetto rotante, per ottica 5 mm, lunghezza utile 175 mm



R612-050175-005

Schaft für Plastische Chirurgie, schnabelförmig, 1 Hahn, drehbar, passend für 5 mm Optik mit 175 mm Nutzlänge

Endo-Plastic Sheath with oblique beak, 1 stopcock rotatable, suitable f. 5 mm scope with 175 mm working length

Camisa para cirugía plástica en forma de pico, con una llave giratoria, para óptica de 5 mm, largo útil de 175 mm

Camicia per chirurgia plastica, a forma di becco, 1 rubinetto rotante, per ottica 5 mm, lunghezza utile 175 mm

Endoskopische Instrumente
Endoscopic Instruments
Instrumentos para endoscopia
Strumenti endoscopici



R633-030160-110

Schere gerade, drehbar für rechte und linke Anwendung, 3 mm Ø, Griff mit HF-Anschluß, isoliert

Endoscopic Scissors, straight, insulated shaft, 3 mm Ø, handle with HF connector, rotatable

Tijera recta, giratoria, para su aplicación hacia la derecha y la izquierda, 3 mm Ø, mango con contacto de alta frecuencia, aislada
Forbice, retta, 3 mm Ø, rotante, per uso a destra e a sinistra, impugnatura con attacco per alta frequenza



R633-030160-112

Schere Metzenbaum, gebogen, drehbar für rechte und linke Anwendung, 3 mm Ø, Griff mit HF-Anschluß, isoliert

Endoscopic Metzenbaum Scissor, curved, insulated shaft, 3 mm Ø, handle with HF connector, rotatable

Tijera curva, giratoria, para su aplicación hacia la derecha y la izquierda, 3 mm Ø, mango con contacto de alta frecuencia, aislada
Forbice Metzenbaum, curva, 3 mm Ø, rotante, per uso a destra e a sinistra, impugnatura con attacco per alta frequenza



R633-030160-116

Hakenschere, drehbar für rechte und linke Anwendung, 3 mm Ø, Griff mit HF-Anschluß, isoliert

Endoscopic Micro Hook Scissor, curved shaft for left or right hand, 3 mm Ø, handle with HF connector, rotatable

Tijera de pico, giratoria, para su aplicación hacia la derecha y la izquierda, 3 mm Ø, mango con contacto de alta frecuencia, aislada
Forbice ad uncino, curva, 3 mm Ø, rotante, per uso a destra e a sinistra, impugnatura con attacco per alta frequenza



R633-030160-212

Maryland Fasszange gebogen, drehbar, für rechte und linke Anwendung, 3 mm Ø, Griff mit HF-Anschluß, isoliert

Endoscopic Curved Grasper, rotating, insulated shaft for left and right, 3 mm Ø, handle with HF connector

Pinza de agarre raspar tipo Maryland, giratoria, para su aplicación hacia la derecha y la izquierda, 3 mm Ø, mango con contacto de alta frecuencia, aislada

Pinza da presa Maryland, curva, rotante, per uso a destra e a sinistra, Ø 3 mm, impugnatura con attacco per alta frequenza



R633-030160-224

Delphinzange, drehbar für rechte und linke Anwendung, 3 mm Ø, Griff mit HF-Anschluß, isoliert

Endoscopic Needle Nose Grasper, rotatable for left and right use, 3 mm Ø, handle with HF connector

Pinza de agarre en forma de delfino, giratoria, para su aplicación hacia la derecha y la izquierda, 3 mm Ø, mango con contacto de alta frecuencia, aislada

Pinza da presa, rotante, per uso a destra e a sinistra, morso a delfino, Ø 3 mm, impugnatura con attacco per alta frequenza



R633-030160-246

Faßzange, retrograd gezahnt, drehbar für rechte und linke Anwendung, 3 mm Ø, Griff mit HF-Anschluß, isoliert

Endoscopic Heavy Grasper, rotatable for left and right, insulated, 3 mm Ø, handle with HF connector

Pinza de agarre, con dentadura en forma retrógrada, giratoria, para la aplicación hacia la derecha y la izquierda, 3 mm Ø, mango con contacto de alta frecuencia, aislada

Pinza da presa, retrograda, rotante, per uso a destra e a sinistra, 3 mm Ø, impugnatura con attacco per alta frequenza

Endoskopische Instrumente
Endoscopic Instruments
Instrumentos para endoscopia
Strumenti endoscopici

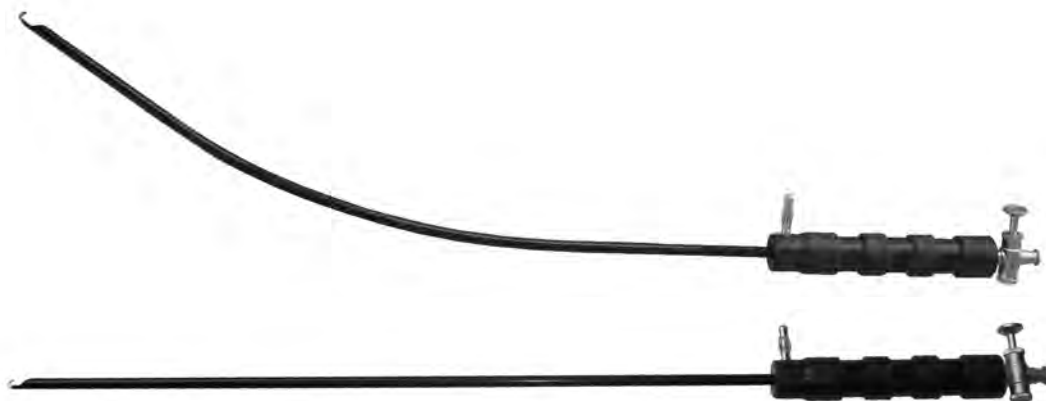

Monopolare Elektroden mit Saugkanal und Hahn, 5 mm Ø, 340 mm Nutzlänge
Monopolare electrodes with suction port and stopcock, 5 mm Ø, 340 mm working length
Electrodos monopolares con canal de succión y llave de 5 mm Ø, largo útil de 340 mm
Elettrodi monopolari con canale d'aspirazione e rubinetto, 5 mm Ø, lunghezza utile 340 mm



J-Haken Elektrode, gerade
J-Hook electrode straight
Electroda forma de gancho, recta
Elettrodo ad uncinetto, retto

R662-050340-002

J-Haken Elektrode, gebogen
J-Hook electrode curved
Electroda forma de gancho, curva
Elettrodo ad uncinetto, curvo

R663-050340-002



Spatel Elektrode, gerade
Spatula electrode straight
Electroda en forma de espátula, recta
Elettrodo a spatola, retto

R662-050340-004

Spatel Elektrode, gebogen
Spatula electrode curved
Electroda en forma de espátula, curva
Elettrodo a spatola, curvo

R663-050340-004

SET/100 Basic Plastic Surgery – Basis Set Plastische Chirurgie

1x	09103-00	scalpel handle no. 3
1x	09115-00	scalpel blade fig. 15
1x	11305-14	JOSEPH, scissors, cvd., 14,5 cm
1x	11310-12	KILNER, scissors, cvd., 12 cm
1x	11340-11	IRIS, scissors, str., 11 cm
1x	11341-11	IRIS, scissors, cvd., 11 cm
2x	13176-12	ADSON micro, dressing forceps, 12 cm
2x	13186-12	ADSON micro, tissue forceps, 1x2 t., 12 cm
4x	15220-12	HALSTED-MOSQUITO, forceps, str., 12,5 cm
6x	15221-12	HALSTED-MOSQUITO, forceps, cvd., 12,5 cm
2x	15320-14	ROCHESTER-OCHSNER, forceps, 1x2 t., str., 14 cm
4x	17111-09	BACKHAUS, towel forceps, 9 cm
2x	19170-18	FOERSTER, swab forceps, str., 18 cm
1x	21216-01	JOSEPH, hooklet, sharp, 1 prong, 16 cm
1x	21216-02	JOSEPH, hooklet, sharp, 2 prongs, 16 cm
1x	21650-10	WEITLANER, retractor, sharp, 11,5 cm
1x	23110-14	grooved director, 14,5 cm
1x	27137-11	BABY WEBSTER, needle holder TC, 11 cm
1x	27164-15	CRILE-WOOD, needle holder TC, 15 cm
1x	49560-18	GILLIES, hooklet, delicate, fig. 1, 18cm
2x	67110-15	ALLIS, tissue forceps, 4x5 t., 15 cm
1x	91127-08	bowl round, stainless steel, 80x40 mm, 0,14 l

SET/101 Abdominplasty Set – Abdominoplastik Set

1x	09104-00	scalpel handle no. 4
1x	09120-00	scalpel blade fig. 20
1x	11165-14	MAYO, scissors TC, cvd., 14,5 cm
1x	12039-23	KAYE, face lift Supercut scissors, cvd., 23 cm
1x	12011-19	GORNEY, face lift scissors, cvd., 18,5 cm
1x	13112-18	POTTS-SMITH, dressing forceps, 18 cm
1x	13126-18	POTTS-SMITH, tissue forceps, 1x2 t., 18 cm
1x	13176-12	ADSON micro, dressing forceps, 12 cm
1x	13186-12	ADSON mirco, tissue forceps, 1x2 t., 12 cm
1x	13188-12	ADSON-BROWN, tissue forceps, 7x7 t., 12 cm
6x	17111-13	BACKHAUS, towel forceps, 13 cm
1x	21102-12	FARABEUF, retractor, double pair, 12 cm
2x	21216-07	JOSEPH, hooklet, sharp, 2 prongs, 16 cm
1x	21364-60	ISRAEL, retractor, blunt, 50x60 mm, 25 cm
1x	27144-13	HALSEY, needle holder TC, 13 cm
1x	27184-16	MAYO-HEGAR, needle holder TC, 16 cm
1x	27184-20	MAYO-HEGAR, needle holder TC, 20 cm

SET/102 Skin Graft Set – Hautverpflanzung Set

1x	05350-15	tape measure metal, 1,5 m
1x	09103-00	scalpel handle no. 3
1x	09115-00	scalpel blade fig. 15
1x	09490-00	SCHINK, dermatome, 30 cm
1x	11283-15	METZENBAUM-FINO, scissors, cvd, 15 cm
1x	11283-18	METZENBAUM-FINO, scissors, cvd., 18 cm
1x	13260-15	SEMKEN. dressing forceps, 15,5 cm
1x	13270-15	SEMKEN, tissue forceps, 1x2 t., 15,5 cm
3x	15221-12	HALSTED-MOSQUITO, forceps, cvd., 12,5 cm
4x	17111-13	BACKHAUS, towel forceps, 13 cm
1x	21212-01	GUTHRIE, double hooklet, small, 12 cm
1x	21240-10	SENN-GREEN, retractor, 10x6mm, 15cm
1x	27214-18	DeBAKEY, needle holder TC, 18 cm
1x	27164-15	CRILE-WOOD, needle holder TC, 15 cm
1x	49560-18	GILLIES, hooklet, delicate, fig. 1, 18 cm
2x	67110-15	ALLIS, tissue forceps, 4x5 t., 15 cm

SET/103 Nose Correction – Nasenkorrektur Set

1x	09107-00	scalpel handle no. 7
1x	09115-00	scalpel blade fig. 15
1x	11304-14	JOSEPH, scissors, str., 14 cm
1x	11310-12	KILNER, scissors, cvd., 12 cm
1x	11321-15	REYNOLDS, scissors, cvd., 15 cm
1x	11401-18	HEYMANN, scissors, 18 cm
1x	13176-12	ADSON micro, dressing forceps, 12 cm
1x	13186-12	ADSON micro, tissue forceps, 1x2 t., 12 cm
1x	13188-12	ADSON-BROWN, tissue forceps, 7x7 t., 12 cm
1x	15220-12	HALSTED-MOSQUITO, forceps, str., 12,5 cm
1x	15223-12	HALSTED-MOSQUITO, forceps, cvd., 12,5 cm
1x	15312-14	PEAN, forceps, str., 14 cm
4x	17111-13	BACKHAUS, towel forceps, 13 cm
1x	19111-20	GROSS-MAIER, dressing forceps, cvd., 20 cm
1x	21212-01	GUTHRIE, double hooklet, 12 cm
1x	21216-02	JOSEPH, hooklet, sharp, 2 prongs, 16 cm
1x	21218-01	BARSKY, hook, 15 cm
1x	21230-12	DESMARRES, retractor, 16 cm
1x	27137-11	BABY WEBSTER, needle holder TC, 11 cm
1x	27164-15	CRILE-WOOD, needle holder TC, 15 cm
1x	35100-01	FRIEDMAN micro, bone rongeur, str., 14 cm
1x	35694-01	mallet with interchangeable plastic, 18,5 cm
1x	35711-16	WILLIGER, raspatory, str., 16cm
1x	35711-20	LANGENBECK, elevator, 20 cm
1x	47206-14	LUCAE, ear forceps, 14 cm
1x	49120-35	KILLIAN, nasal speculum, 35 mm, 13 cm
1x	49120-50	KILLIAN, nasal speculum, 50 mm, 13 cm
1x	49224-01	WEIL-BLAKESLEY, forceps, fig. 1, 45°, 3 mm
1x	47256-20	CAPLAN, nasal cutting forceps, 20 cm
1x	49347-20	GUILLEN, suction raspatory, 19 cm
1x	49374-16	FREER, mucosa knife, 16,5 cm
1x	49423-22	COTTLE, septum elevator, 22 cm
1x	49454-04	COTTLE, rhinoplastic osteotome, 18 cm
1x	49454-07	COTTLE, rhinoplastic osteotome, 18 cm
1x	49470-04	FOMON, osteotome, 17 cm
1x	49522-05	FOMON, nasal raspel TC, fig. 5/6, 20 cm
1x	49551-16	AUFRICHT, nasal retractor, 16 cm
1x	49555-08	KILNER, nasal retractor, 8 cm
1x	49565-10	COTTLE, columella forceps, 10 cm
1x	49571-23	ASCH, septum forceps, str., 23 cm
1x	91127-08	bowl round, stainless steel, 80x40 mm, 0,14 l

SET/104 Face Lift Set

1x	05370-16	PITANGUY, facelift marker, 16 cm
1x	09107-00	scalpel handle no. 7
1x	09115-00	scalpel blade fig. 15
1x	11345-11	IRIS, scissors TC, cvd., 11 cm
1x	12015-19	GORNEY, face lift Supercut scissors, cvd., 18,5 cm
1x	12045-14	PECK-JOSEPH, dissecting scissors, cvd., 14,5 cm
1x	13176-12	ADSON micro, dressing forceps, 12 cm
1x	13186-12	ADSON micro, tissue forceps, 1x2 t., 12 cm
1x	13188-12	ADSON-BROWN, tissue forceps, 7x7 t., 12 cm
1x	13231-20	BROPHY, tissue forceps, 1x2 t., 20 cm
1x	15364-14	MARTEL, scalp flap forceps, 14 cm
1x	21102-12	FARABEUF, retractor double pair, 12 cm
1x	21216-02	JOSEPH, hooklet, sharp, 2 prongs, 16 cm
1x	21314-16	KOCHER-LANGENBECK, retractor, 21 cm
1x	21995-38	FREEMAN, retractor, sharp, 4 prongs, 18 cm
1x	27144-13	HALSEY, needle holder TC, 13 cm
1x	27164-15	CRILE-WOOD, needle holder TC, 15 cm
1x	49560-18	GILLIES, hooklet, delicate, fig. 1, 18 cm

**SET/105 Eyelid Plastic (Blepharoplasty) –
Set zur Lidstraffung (Blepharoplastik)**

1x	09103-00	scalpel handle no. 3
1x	09115-00	scalpel blade fig. 15
1x	11341-11	IRIS, scissors, cvd., 11 cm
1x	11362-11	STEVENS, scissors, str. 11 cm
1x	12313-14	GOMEL, scissors, cvd., 14 cm
1x	13186-12	ADSON micro, tissue forceps, 1x2 t., 12 cm
1x	15220-12	HALSTED-MOSQUITO, forceps, str., 12,5 cm
1x	15221-12	HALSTED-MOSQUITO, forceps, cvd., 12,5 cm
4x	17111-09	BACKHAUS, towel forceps, 9 cm
1x	21216-01	JOSEPH, hooklet, sharp, 1 prong, 16 cm
1x	21216-02	JOSEPH, hooklet, sharp, 2 prongs, 16 cm
1x	21230-12	DESMARRES retractor, 16 cm
1x	27670-14	CASTROVIEJO, needle holder, str., 14
cm 1x	46150-01	CASTROVIEJO, suturing forceps, 0,1 mm, 10 cm
1x	49560-18	GILLIES, hooklet, delicate, fig. 1, 18 cm

SET/106 Mammoplasty – Mammoplastik Set

1x	05340-20	ruler metal, 20 cm
1x	05500-38	FREEMAN, marker, 38 mm
1x	03500-42	FREEMAN, marker, 42 mm
1x	05500-44	FREEMAN, marker, 44 mm
1x	09107-00	scalpel handle no. 7
1x	09115-00	scalpel blade fig. 15
1x	11281-18	METZENBAUM, scissors, 18 cm
1x	11310-15	KILNER, scissors, 15 cm
1x	11583-15	neurosurgery scissors, cvd., 15 cm
1x	12102-14	dressing forceps, 14,5 cm
1x	11186-12	ADSON micro, tissue forceps, 1x2 t., 12 cm
2x	15223-12	HALSTED-MOSQUITO, micro, forceps, cvd., 12,5 cm
2x	15231-12	HALSTED-MOSQUITO, forceps, cvd., 12,5 cm
1x	15475-18	MIXTER BABY, forceps, 18 cm
6x	17111-13	BACKHAUS, towel forceps, 13 cm
1x	17110-25	GROSS-MAIER, dressing forceps, 25 cm
1x	21102-12	FARABEUF, retractor double par, 12 cm
1x	21314-12	KOCHER-LANGENBECK, retractor, 21 cm
1x	21999-00	AGRIS-DINGMAN, breast dissector, set of 2, 36 cm
1x	21999-02	TEBBETTS, breast dissector, 33 cm
1x	27164-15	CRILE-WOOD, needle holder TC, 15 cm
1x	27180-16	MAYO-HEGAR, needle holder, 16 cm
1x	49154-20	JANSEN, nasal forceps, 20 cm
1x	91127-08	bowl round, stainless steel, 80x40mm, 0,14 l

05312-01.2	09116-00.11	11281-15.16	11305-14.18	11374-1124
05314-01.2	09118-00.11	11281-18.16	11310-12.19	11375-1124
05340-10.2	09119-00.11	11281-20.16	11310-15.19	11984-1124
05340-15.2	09120-00.11	11281-23.16	11314-12.19	11985-1124
05340-20.2	09121-00.11	11284-12.16	11321-15.19	11823-12.25
05340-30.2	09122-00.11	11284-15.16	11321-18.19	11824-12.25
05340-50.2	09123-00.11	11284-18.16	11540-16.19	11825-12.25
05370-16.3	09124-00.11	11284-20.16	11541-16.19	11826-12.25
05380-30.3	09125-00.11	11284-23.16	11542-16.19	11828-12.25
05390-30.3	09130-00.11	11285-12.16	11543-16.19	11829-12.25
05400-38.4	95385-21.12	11285-15.16	11544-16.19	11982-12.25
05400-42.4	95385-25.12	11285-18.16	11545-16.19	11983-12.25
05400-45.4	95390-21.12	11285-20.16	11993-15.19	11854-1126
05500-38.4	11160-14.13	11285-23.16	11995-12.19	11855-1126
05500-42.4	11160-17.13	11966-1116	11340-09.20	11401-18.27
05500-44.4	11161-14.13	11967-1116	11340-10.20	11403-15.27
45583-07.4	11161-17.13	11970-14.16	11340-1120	11405-16.27
45583-18.4	11164-14.13	11970-18.16	11341-09.20	11405-16TC ...27
75193-30.4	11164-17.13	11970-20.16	11341-10.20	11406-10.27
09490-00.5	11165-14.13	11970-23.16	11341-1120	11407-10.27
09490-01.5	11165-17.13	11971-14.16	11342-08.20	11617-13.27
09490-02.5	11962-14.13	11971-18.16	11343-08.20	11802-09.28
09495-31.6	11962-17.13	11971-20.16	11344-1120	11802-1128
09296-00.6	11963-14.13	11971-23.16	11345-1120	11804-14.28
09496-31.6	11963-17.13	11270-15.17	11346-1120	11805-09.28
09498-00.6	11170-15.14	11270-18.17	11980-1120	11614-19.29
09499-00.6	11170-17.14	11271-15.17	11981-1120	11820-13.29
09499-01.6	11171-15.14	11271-18.17	11348-01.21	11821-13.29
09103-00.7	11171-17.14	11274-15.17	11348-02.21	11821-13SC...29
09103-01.7	11174-15.14	11274-18.17	11348-03.21	12010-19.30
09103-02.7	11174-17.14	11275-15.17	11348-04.21	12011-19.30
09103-03.7	11175-15.14	11275-18.17	11348-05.21	12012-19.30
09104-00.8	11175-17.14	11282-15.17	11348-06.21	12013-19.30
09104-02.8	11964-15.14	11282-18.17	11349-12.22	12014-19.30
09105-02.8	11964-17.14	11282-20.17	11350-10.22	12015-19.30
09106-01.8	11965-15.14	11282-23.17	11352-10.22	12061-19.30
09107-00.9	11965-17.14	11283-15.17	11358-1122	12061-19TC ...30
09107-01.9	11190-16.15	11283-18.17	11350-09.23	12061-19SC...30
09108-00.9	11191-16.15	11283-20.17	11351-09.23	12061-23.30
09109-10.10	11194-16.15	11283-23.17	11352-09.23	12061-23TC ...30
09109-13.10	11195-16.15	11286-15.17	11353-09.23	12061-23SC...30
09109-15.10	11202-10.15	11286-18.17	11354-10.23	12028-14.31
09161-00.10	11203-10.15	11286-20.17	11355-10.23	12029-14.31
09162-00.10	11206-10.15	11286-23.17	11356-10.23	12030-18.31
09165-00.10	11207-10.15	11287-15.17	11357-10.23	12031-18.31
09167-00.10	11280-12.16	11287-18.17	11360-1124	12032-23.31
09110-00.11	11280-15.16	11287-20.17	11361-1124	12033-23.31
09111-00.11	11280-18.16	11287-23.17	11362-1124	12034-14.31
09112-00.11	11280-20.16	11302-14.18	11363-1124	12035-14.31
09113-00.11	11280-23.16	11303-14.18	11370-1124	12036-18.31
09115-00.11	11281-12.16	11304-14.18	11371-1124	12037-18.31

12038-23.31	12227-18T.....35	13116-18.36	13180-12.39	13302-17.....43
12039-23.31	12227-21.35	13116-21.36	13180-12F.....39	13302-23.43
12044-14.31	12227-23.35	13116-25.36	13180-15.39	13303-17.43
12045-14.31	12228-11.....35	13126-18.36	13181-12.39	13304-17.43
12048-14.31	12228-14.35	13126-21.36	13181-15.39	13305-17.44
12049-14.31	12228-18.35	13126-25.36	13182-12.39	13310-17.44
12050-14.31	12228-18T.....35	13120-10.37	13186-12.39	13311-17.44
12050-18.31	12228-21.35	13120-11.37	13186-15.39	13312-17.44
12051-14.31	12228-23.35	13120-13.37	13187-12.39	13312-18.44
12051-18.31	12229-11.....35	13120-14.37	13188-12.40	13313-17.44
12201-11.....32	12229-14.35	13120-16.37	13188-12F.....40	13314-01.44
12201-11SC...32	12229-18.35	13120-18.37	13188-15.40	13314-02.44
12206-11.....32	12229-18T.....35	13120-20.37	13189-12.40	13315-01.44
12206-11SC...32	12229-21.35	13122-12.37	13191-12.40	13315-02.44
12207-11.....32	12229-23.35	13122-13.37	13187-18.41	13316-14.45
12207-11SC...32	12230-11.....35	13122-14.37	13187-20.41	13316-16.45
12202-11.....33	12230-14.35	13122-15.37	13187-25.41	13316-20.45
12202-14.33	12230-18.35	13122-18.37	13187-30.41	13317-00.45
12202-14T.....33	12230-18T.....35	13122-21.37	13189-15.41	13317-12.45
12202-18.33	12230-21.35	13124-15.37	13189-20.41	13317-23.45
12202-18T.....33	12230-23.35	13130-11.37	13189-25.41	13318-18.45
12202-21.33	13102-10.36	13130-13.37	13190-10.41	13318-20.45
12202-21T.....33	13102-11.36	13130-14.37	13220-17.41	13318-25.45
12202-23.33	13102-13.36	13130-16.37	13221-17.41	13319-12.45
12203-11.....33	13102-14.36	13130-18.37	13222-17.41	13319-14.45
12203-14.33	13102-16.36	13130-20.37	13223-17.41	13320-18.45
12203-14T.....33	13102-18.36	13132-16.37	13224-17.41	13320-23.45
12203-18.33	13102-20.36	13132-18.37	13225-17.41	13401-01.46
12203-18T.....33	13103-14.36	13132-20.37	13232-15.41	13403-03.46
12203-21.33	13104-12.36	13140-11.37	13246-18.42	13403-04.46
12203-21T.....33	13104-13.36	13140-13.37	13248-18.42	13404-04.46
12203-23.33	13104-14.36	13140-14.37	13250-14.42	13405-05.46
12220-00.34	13104-15.36	13140-16.37	13252-20.42	13407-07.46
12220-00T.....34	13104-18.36	13140-18.37	13256-15.42	14090-15D...47
12220-25.34	13104-21.36	13140-20.37	13256-20.42	14090-18D...47
12220-25T.....34	13106-13.36	13150-13.37	13256-25.42	14090-21D...47
12220-45.34	13106-15.36	13150-14.37	13257-15.42	14090-23D...47
12220-45T.....34	13110-13.36	13150-16.37	13258-15.42	14091-15D...47
12220-60.34	13110-13.36	13160-13.37	13259-15.42	14091-18D...47
12220-60T.....34	13110-14.36	13160-14.37	13260-12.43	14091-21D...47
12220-90.34	13110-16.36	13160-16.37	13260-15.43	14091-23D...47
12220-90T.....34	13110-18.36	13170-12.38	13261-15.43	14102-12.47
12226-11.....35	13110-20.36	13170-12F.....38	13270-12.43	14102-12D...47
12226-14.35	13110-25.36	13170-15.38	13270-15.43	14102-21.47
12226-18.35	13112-18.36	13174-12.38	13271-15.43	14102-21D...47
12226-18T.....35	13112-21.36	13174-15.38	13271-18.43	14102-23.47
12226-21.35	13112-25.36	13176-12.38	13272-15.43	14102-23D...47
12226-23.35	13114-14.36	13176-15.38	13273-15.43	14103-12.47
12227-11.....35	13114-16.36	13177-12.38	13274-06.43	14103-12D...47
12227-14.35	13114-20.36	13178-12.38	13274-08.43	14103-15.47
12227-18.35	13114-25.36	13179-12.38	13274-10.43	14103-15D...47

14104-15.....47	14306-16.....51	49565-10.....57	15255-14.....62	21187-25.....67
14104-15D.....47	14306-20.....51	45150-11.....58	15260-14.....62	21188-12.....68
14108-18.....47	14306-24.....51	15210-10.....59	15261-14.....62	21188-12CL...68
14108-18D.....47	14306-30.....51	15211-10.....59	15262-16.....62	21210-12.....69
14109-18.....47	14308-16.....51	15212-10.....59	15263-16.....62	21211-12.....69
14109-18D.....47	14308-20.....51	15213-10.....59	15264-16.....62	21212-01.....69
14109-21.....47	14308-24.....51	15214-10.....59	15265-16.....62	21212-02.....69
14109-21D.....47	14308-30.....51	15215-10.....59	15310-13.....63	21213-12.....69
14109-23.....47	14309-16.....51	15220-12.....60	15310-14.....63	21214-13.....70
14109-23D.....47	14309-20.....51	15220-14.....60	15310-16.....63	21214-18.....70
14112-15D.....48	14309-24.....51	15220-18.....60	15311-13.....63	21215-01.....70
14112-15T.....48	14309-30.....51	15220-21.....60	15311-14.....63	21215-02.....70
14112-18D.....48	14310-16.....51	15221-12.....60	15311-16.....63	21215-03.....70
14112-18T.....48	14310-20.....51	15221-14.....60	15320-13.....63	21215-13.....70
14112-21D.....48	14310-24.....51	15221-18.....60	15320-14.....63	21215-18.....70
14112-21T.....48	14310-30.....51	15221-21.....60	15320-16.....63	21216-01.....70
14112-23D.....48	45810-10.....52	15222-12.....60	15321-13.....63	21216-02.....70
14112-23T.....48	45811-10.....52	15223-12.....60	15321-14.....63	21216-05.....70
14114-15D.....48	45813-10.....52	15224-12.....60	15321-16.....63	21216-07.....70
14114-15T.....48	45820-10.....52	15225-12.....60	15380-15.....63	21216-10.....70
14114-18D.....48	45821-10.....52	15226-12.....60	15381-15.....63	21217-03.....70
14114-18T.....48	45823-10.....52	15227-12.....60	15382-15.....63	21217-05.....70
14114-21D.....48	45940-05.....53	15230-12.....60	15383-15.....63	21217-07.....70
14114-21T.....48	45940-08.....53	15230-14.....60	15410-18.....64	21218-01.....71
14114-23D.....48	45942-05.....53	15230-18.....60	15411-18.....64	21218-02.....71
14114-23T.....48	45942-08.....53	15230-21.....60	21102-12.....65	21218-11.....71
14115-15.....49	45950-10.....54	15231-12.....60	21102-15.....65	21220-01.....72
14115-15T.....49	45952-10.....54	15231-14.....60	21124-15.....65	21220-02.....72
14115-18.....49	45953-10.....54	15231-18.....60	21125-14.....65	21220-03.....72
14115-18T.....49	46015-20.....55	15231-21.....60	21127-11.....65	21220-04.....72
14115-21.....49	46015-27.....55	15232-12.....60	21168-06.....66	21221-01.....72
14115-21T.....49	46150-01.....55	15233-12.....60	21168-08.....66	21221-02.....72
14115-23.....49	46150-03.....55	15240-14.....61	21168-10.....66	21221-03.....72
14115-23T.....49	46150-05.....55	15240-18.....61	21168-12.....66	21221-04.....72
14116-15.....49	46150-10.....55	15241-14.....61	21168-17.....66	21226-02.....72
14116-18.....49	46150-15.....55	15241-18.....61	21168-20.....66	21226-03.....72
14116-21.....49	46254-09.....55	15242-16.....61	21168-25.....66	21226-04.....72
14116-23.....49	46256-09.....55	15243-16.....61	21169-25.....66	21227-02.....72
14117-18.....50	46258-09.....55	15244-14.....61	21170-20.....66	21227-03.....72
14117-21.....50	46425-10.....55	15245-14.....61	21170-25.....66	21227-04.....72
14117-23.....50	46076-05.....56	15256-14.....61	21170-32.....66	21229-02.....72
14118-18.....50	46076-10.....56	15257-14.....61	21170-40.....66	21229-03.....72
14118-21.....50	46078-05.....56	15258-16.....61	21170-45.....66	21230-10.....73
14118-23.....50	46078-10.....56	15259-16.....61	21170-50.....66	21230-12.....73
14302-16.....51	47201-11.....57	15270-14.....61	21170-65.....66	21230-14.....73
14302-20.....51	47206-14.....57	15271-14.....61	21170-76.....66	21230-16.....73
14302-24.....51	47206-16.....57	15250-14.....62	21180-19.....67	21230-18.....73
14304-16.....51	47208-14.....57	15250-18.....62	21181-22.....67	21234-00.....73
14304-20.....51	49151-15.....57	15251-14.....62	21181-25.....67	21237-16.....73
14304-24.....51	49151-18.....57	15251-18.....62	21183-25.....67	21270-02.....73
14304-30.....51	49154-20.....57	15254-14.....62	21185-25.....67	21270-03.....73

21270-04.73	21980-05.78	49560-18.89	27225-20.93	95251-18T.....95
21270-06.73	21980-06.78	49562-18.89	27230-18.93	95251-21T.....95
21271-02.73	21970-01.79	49563-22.89	27230-20.93	95260-15T.....95
21271-03.73	21980-18.79	49564-16.89	27405-12.93	95260-18T.....95
21271-04.73	21990-18.79	49566-12.89	27406-12.93	95260-21T.....95
21271-06.73	21991-18.79	49567-11.....89	27407-12.93	95261-15T.....95
21302-01.74	21995-22.79	49568-08.89	27408-12.93	95261-18T.....95
21302-02.74	21995-38.79	57116-15.90	27410-14.93	95261-21T.....95
21302-03.74	21998-03.79	57117-17.90	27410-17.93	27668-18.96
21302-04.74	21998-05.79	57120-15.90	27414-14.93	27668-21.96
21302-05.74	21992-31.80	27110-12.91	27414-17.93	27668-23.96
21302-06.74	21996-04.81	27114-12.91	27414-18.93	27670-14.96
21307-01.74	21997-09.81	27128-13.91	27434-11.....94	27670-18.96
21307-02.74	21999-00.82	27129-13.91	27434-13.94	27670-21.96
21610-07.75	21999-01.83	27130-13.91	27434-16.94	27671-14.96
21611-07.75	21999-02.83	27134-13.91	27660-12.95	27671-18.96
21620-07.75	21999-03.83	27136-11.....91	27660-13.95	27672-14.96
21620-10.75	21999-04.83	27137-11.....91	27660-14.95	27672-14D96
21621-07.75	21999-30.84	27140-13.91	27661-12.95	27672-14T.....96
21621-10.75	21999-30CL ..84	27144-13.91	27661-13.95	27672-18.96
21630-10.75	21999-50.84	27150-12.92	27661-14.95	27672-18D96
21631-10.75	21999-50CL ..84	27150-14.92	27671-12D ...95	27672-18T.....96
21634-10.75	43054-20.85	27154-12.92	27671-13D ...95	27672-21.96
21635-10.75	43056-18.85	27154-14.92	27671-14D ...95	27672-21D96
21650-10.76	43058-18.85	27160-15.92	27700-18.95	27672-21T.....96
21651-10.76	43068-20.85	27160-18.92	27701-18.95	27672-23.96
21670-14.76	43069-20.85	27164-15.92	27720-12.95	27672-23D96
21671-14.76	45370-12.86	27164-18.92	27720-12D ...95	27673-14.96
21741-01.77	45372-13.86	27164-20.92	27720-13.95	27673-14D96
21741-02.77	45373-13.86	27164-23.92	27720-13D ...95	27673-14T.....96
21741-03.77	45376-13.86	27180-12.92	27720-14.95	27673-18.96
21741-04.77	45377-13.86	27180-14.92	27720-14D ...95	27673-18D96
21741-05.77	45378-13.86	27180-16.92	27730-18.95	27673-18T.....96
21741-06.77	49538-01.87	27180-18.92	27730-18D ...95	27673-21T.....96
21741-07.77	49538-02.87	27180-20.92	27730-21.95	27674-14.96
21741-08.77	49538-03.87	27184-12.92	27730-21D ...95	27674-18.96
21741-09.77	49538-04.87	27184-14.92	27730-23.95	27674-21.96
21741-10.77	49540-16.87	27184-16.92	27730-23D ...95	27675-14.96
21741-11.....77	49550-11.....87	27184-18.92	27731-12.95	27675-18.96
21741-12.77	49551-16.87	27184-20.92	27731-13.95	27676-14.96
21741-13.77	49551-16L.....87	27214-16.92	27731-14.95	27677-14.96
21960-01.78	49552-16.87	27214-18.92	27731-18.95	27691-18.96
21960-02.78	49553-15.87	27214-20.92	27731-18D ...95	36554-15.97
21960-03.78	49554-01.88	27214-23.92	27731-21.95	36554-18.97
21960-04.78	49554-02.88	27224-13.93	27731-21D ...95	36554-20.97
21960-05.78	49554-03.88	27224-15.93	27731-23.95	36555-15.97
21960-06.78	49555-08.88	27224-18.93	27731-23D ...95	36555-18.97
21980-01.78	49556-16.88	27224-20.93	95250-15T.....95	36555-20.97
21980-02.78	49557-17.88	27225-13.93	95250-18T.....95	36556-18.97
21980-03.78	49558-15.88	27225-15.93	95250-21T.....95	35100-01.98
21980-04.78	49559-20.88	27225-18.93	95251-15T.95	35100-02.98



MT- Braun Instrumente

35101-12.....98	51281-02.....106	49169-18.....118	49382-15.....125	35654-04.....132
35101-14.....98	43290-21.....107	49185-18.....118	49384-15.....125	35654-05.....132
35201-18.....98	43299-03.....107	49191-01.....119	49385-15.....125	35654-06.....132
35211-15.....98	43299-05.....107	49191-02.....119	49386-01.....125	35654-08.....132
35213-15.....98	43299-07.....107	49191-03.....119	49386-02.....125	35654-10.....132
35280-15.....99	43295-06.....108	49191-04.....119	49390-03.....126	35654-12.....132
35281-15.....99	43295-07.....108	49192-16.....119	49390-04.....126	35654-15.....132
35282-19.....99	43295-08.....108	49195-01.....119	49390-05.....126	49482-05.....132
35283-17.....99	43295-09.....108	49195-02.....119	49392-03.....126	49484-04.....132
35686-25.....100	43295-10.....108	49197-01.....119	49392-04.....126	49484-06.....132
35693-32.....100	43295-11.....108	49197-02.....119	49392-05.....126	49484-08.....132
35694-01.....100	43295-12.....108	49223-01.....120	49394-27.....127	49486-16.....132
35694-02.....100	43297-06.....108	49223-02.....120	49450-04.....128	49487-16.....132
35694-03.....100	43297-07.....108	49223-03.....120	49451-04.....128	49489-16.....132
35696-75.....100	43297-08.....108	49223-04.....120	49453-03.....128	49461-00.....133
35698-98.....100	43297-09.....108	49223-05.....120	49454-04.....129	49462-00.....133
35700-05.....100	43297-10.....108	49224-01.....120	49454-07.....129	49502-16.....134
35711-16.....101	43297-11.....108	49224-02.....120	49454-09.....129	49504-18.....134
35711-20.....101	43297-12.....108	49224-03.....120	49454-12.....129	49507-17.....134
35711-21.....101	49347-20.....109	49224-04.....120	49455-06.....129	49507-18.....134
35712-16.....101	49102-01.....110	49224-05.....120	49458-04.....129	49523-01.....134
35713-17.....101	49102-02.....110	49225-01.....120	49458-07.....129	49523-02.....134
35718-16.....101	49102-03.....110	49225-02.....120	49458-09.....129	49524-01.....134
35719-17.....101	49103-01.....111	49225-03.....120	49458-12.....129	49525-20.....134
35720-19.....102	49103-02.....111	49225-04.....120	49460-04.....129	49526-20.....134
35720-21.....102	49103-03.....111	49226-01.....120	49460-07.....129	49511-21.....135
49410-04.....102	49112-01.....112	49226-02.....120	49460-12.....129	49513-21.....135
49410-05.....102	49112-02.....112	49226-03.....120	49463-10.....129	49514-16.....135
49411-16.....102	49112-03.....112	49227-01.....120	49463-12.....129	49516-16.....135
49414-21.....102	49116-13.....112	49227-02.....120	49463-14.....129	49518-21.....135
49415-18.....102	49118-13.....112	49227-03.....120	49473-01.....130	49520-21.....136
49417-19.....102	49120-35.....113	49237-01.....121	49473-02.....130	49522-01.....137
49419-19.....102	49120-50.....113	49237-02.....121	49473-03.....130	49522-04.....137
49420-01.....103	49120-75.....113	49239-01.....121	49474-01.....130	49522-05.....137
49420-02.....103	49120-90.....113	49239-02.....121	49474-02.....130	49522-07.....137
49420-03.....103	49120-35S.....114	49242-00.....121	49474-03.....130	49522-09.....137
49420-04.....103	49120-50S.....114	49242-01.....121	49481-05.....130	49530-00.....138
49420-20.....103	49120-75S.....114	49251-21.....122	49475-04.....131	49530-01.....138
49421-21.....103	49120-90S.....114	49256-20.....122	49475-06.....131	49530-02.....138
49421-23.....103	49124-35.....115	49323-19.....123	49475-08.....131	49531-00.....138
49422-22.....103	49124-50.....115	49325-19.....123	35652-02.....132	49532-19.....138
49423-22.....104	49124-75.....115	49370-16.....124	35652-03.....132	49533-19.....138
49424-16.....104	49124-90.....115	49371-16.....124	35652-04.....132	49534-19.....138
49425-19.....104	49124-35S.....116	49372-16.....124	35652-05.....132	49535-01.....139
49426-22.....104	49124-50S.....116	49373-16.....124	35652-06.....132	49535-02.....139
49428-21.....104	49124-75S.....116	49374-16.....124	35652-08.....132	49571-23.....140
49430-22.....104	49124-90S.....116	49375-16.....124	35652-10.....132	49572-23.....140
51278-01.....105	49158-20.....117	49375-19.....124	35652-12.....132	49573-23.....140
51278-02.....105	49159-20.....117	49376-16.....124	35652-15.....132	49575-23.....140
51280-18.....105	49161-16.....117	49379-16.....125	35654-02.....132	51115-01.....141
51281-01.....106	49161-20.....117	49380-15.....125	35654-03.....132	51115-02.....141

51117-11 141	51630-02..... 148	R602-050175-030 152
51274-09..... 141	51635-18..... 149	R602-100178-030 152
51274-11 141	51640-05..... 149	R612-050175-070 153
51274-13..... 141	51640-07..... 149	R612-050175-110 153
51274-15..... 141	51640-09..... 149	R612-050175-115 153
51310-00..... 142	51650-06..... 149	R612-050175-001 154
51310-01..... 142	51650-07..... 149	R612-050175-005 155
51310-02..... 142	51650-09..... 149	R633-030160-110 156
51310-03..... 142	51650-11 149	R633-030160-112 156
51310-04..... 142	51660-18..... 150	R633-030160-116 156
51310-05..... 142	51680-10..... 150	R633-030160-212 157
51310-09..... 142	51680-20..... 150	R633-030160-224 157
51310-10..... 142	51685-21..... 150	R633-030160-246 157
51310-11 142	51691-15..... 150	R662-050340-002 158
51310-12..... 142	51692-15..... 150	R662-050340-004 158
51315-00..... 143	51666-10..... 151	R663-050340-002 158
51315-01..... 143	51666-15..... 151	R663-050340-004 158
51315-02..... 143	51666-20..... 151	
51315-03..... 143	51667-10..... 151	
51315-10..... 143	51667-15..... 151	
51317-00..... 143	51700-01..... 151	
51317-01..... 143	51700-02 151	
51317-02..... 143		
51317-03..... 143		
51317-10..... 143		
51320-00..... 144		
51320-01..... 144		
51320-02..... 144		
51320-03..... 144		
51320-10..... 144		
51320-20..... 144		
51340-00..... 144		
51342-01..... 145		
51342-02..... 145		
51342-03..... 145		
51342-04..... 145		
51342-05..... 145		
51605-07..... 146		
51605-10..... 146		
51605-11 146		
51605-12..... 146		
51605-14..... 146		
51605-16..... 146		
51610-12..... 147		
51610-13..... 147		
51610-16..... 147		
51613-10..... 148		
51615-12..... 148		
51620-15..... 148		
51623-16..... 148		
51627-01..... 148		

A	Blepharoplastik Schere, GREEN-BERG-PAR32	COTTLE-JOSEPH, Septumelevator ..103
ADSON, Arterienklemme64	Blepharoplastik Schere, KAYE32	COTTLE-KAZANJIAN, Knochensplitterzange99
ADSON, Durahaken85	BÖHLER, Hohlmeißelzange98	COTTLE-MASING, Nasenschere ..27
ADSON, Pinzette38,39	BÖHLER, Knochensplitterzange99	COTTLE-NEIVERT, Hauthäkchen ..88
ADSON, Saugrohr107	BOIES, Elevator102	CRILE, Arterienklemme62
ADSON-BROWN, Pinzette40	BONN, Schere20	CRILE, Nervhaken85
AGRIS-DINGMAN, Brustdissektor ..82	BONNEY, Pinzette45	CRILE, Wundhaken65
ALM, Wundhaken75	BREAST, Wundhaken79	CRILE-RANKIN, Arterienklemme ..62
Anatomische Pinzette36	BROWN, Pinzette41	CRILE-WOOD, Nadelhalter92
ANDERSON, Hauthäkchen79	BRUENINGS, Septumzange119	CRIONIN, Gaumenspalt-Messer ..105
ANDREW, Zungenspatel141	Brustdissektor, AGRIS-DINGMAN ..82	CUSHING (TAYLOR), Pinzette44
Antrumraspel, WIENER134	Brustdissektor, SILVERSTEIN83	CUSHING, Pinzette41
Arterienklemme, ROCHESTER-PEAN ..63	Brustdissektor, TEBBETTS83	CUSHING, Nervenhaken85
Arterienklemme, ADSON64	Brustdissektor, MacCOLLUM-DINGMAN83	
Arterienklemme, COLLER-CRILE ..61	Brustspatel80	D
Arterienklemme, CRILE62	Bügel, McIVOR144	Darmspatel, RIBBON66
Arterienklemme, CRILE-RANKIN ..62		D'ASSUMPACO, Markierungsinstrument3
Arterienklemme, HALSTED-MOSQUITO ..60	C	DAVIS-BOYLE, Mundsperrerr142
Arterienklemme, HARTMANN59	CAPLAN, Nasenzange122	DAVIS-BOYLE, Zungenspatel142
Arterienklemme, JACOBSON Micro ..60	CASTROVIEJO, Meißinstrument4	DAVIS-MEYER, Mundsperrerr144
Arterienklemme, KELLY61	CASTROVIEJO, Meßzirkel4	DeBAKEY, Nadelhalter92
Arterienklemme, KELLY-RANKIN ..61	CASTROVIEJO, Mikro-Nadelhalter ...96	DEAVER, Wundhaken67
Arterienklemme, LERICHE63	CASTROVIEJO, Nahtpinzette55	DeBAKEY, Atrauma Pinzette ..49,50,51
Arterienklemme, PROVIDENCE-HOSPITAL61	CHADWICK, Zahnfleissschere26	Delphinzange für plastische Endoskopie157
Arterienklemme, ROCHESTER-OCHSNER63	Chalazionspinzette, DESMARRES ...55	DERF, Nadelhalter91
ASCH, Septumrichtzange140	Chirurgische Pinzette37	Dermatom, HUMBY6
Atrauma Pinzette, DeBAKEY ..47,48,51	Cilienpinzette, BARRAQUER55	Dermatom, SCHINK5
AUFRICHT, Nasenhaken87	COLLER-CRILE, Arterienklemme ..61	Dermatom, SILVER6
AUFRICHT, Nasenraspel135	COLLIER, Beckenzirkel4	Dermatom, WATSON6
	COLLIN-DUVAL, Fußpinzette42	DESMARRES, Chalazionspinzette ...55
B	Columella-Pinzette, COTTLE57	DESMARRES, Wundhaken73
BABY OLSEN-HEGAR, Nadelhalter ..93	CONVERSE, Nasenhaken87,89	DINGMANN, Nasenraspel138
BABY WEBSTER, Nadelhalter91	CONVERSE, Nasenmesser125	DINGMANN, Elevator150
BALLENGER, Schwingmesser126	CONVERSE/WILMER, Schere22	DINGMANN, Mundsperrerr143
BALLENGER, Septumelevator104	CORONAL, Wundhaken79	DINGMANN, Raspator150
BARON, Saugrohr107	COTTLE, Columella-Pinzette57	DINGMANN, Sperrerr143
BARRAQUER, Cilienpinzette55	COTTLE, Fixierpinzette57	DINGMANN, Zungenspatel143
BARRAQUER, Nadelhalter95	COTTLE, Hauthäkchen88,89	Dissektor, GORNEY102
BARSKY, Hauthäkchen71	COTTLE, Knorpelquetscher133	Drahtbürste138
BAUMGARTNER, Nadelhalter92	COTTLE, Nasenhaken87	Drahtzange TC, BERRY97
BEASELEY BABCOCK, Pinzette ..39	COTTLE, Nasenmesser125	Drahtzange TC, MAYO-HABERISSER97
Beckenzirkel, COLLIER4	COTTLE, Nasenschere27	Durahaken, ADSON85
BERKE, Muskelpinzette55	COTTLE, Nasenspekula115,116	DURANTE, Fußpinzette45
BERRY, TC-Drahtzange97	COTTLE, Osteotom129	DUVAL, Fußpinzette42
BEUSE, Face-Lift-Schere31	COTTLE, Schere22	
BEYER, Hohlmeißelzange98	COTTLE, Septumelevator103,104	
BIGGS, Wundhaken84	COTTLE, Septummeißel129	
BISHOP-HARMAN, Irispinzette53	COTTLE, Septumosteotom129	
BLAIR, Gaumenspalt-Elevator106	COTTLE, Stahlhammer100	

E	FOMON, Hauthäkchen88	HALSEY, Nadelhalter91
Elevator, BALLENGER104	FOMON, Nasenraspel136	HALSTED-MOSQUITO, Arterien-
Elevator, BOIES102	FOMON, Nasenschere27	klemme60
Elevator, COTTLE-JOSEPH ..103,104	FOMON, Raspator101	Hammer100
Elevator, DINGMANN150	FRAZIER, Hauthäkchen70	Hammer, COTTLE100
Elevator, FREER102	FRAZIER/FERGUSSON, Saugrohr..108	Hammer, GERZOG100
Elevator, HAJEK-BALLENGER104	FREEMAN, Markierungsinstrument.....4	Hammer, MEAD100
Elevator, HOWARTH103	FREEMAN, Wundhaken68,79,81	Hammer, PARTSCH100
Elevator, JOSEPH102	FREER, Hauthäkchen88	Hammer, QUISLING100
Elevator, KILLIAN103,104	FREER, Mukosamesser124	HARTMANN, Arterienklemme59
Elevator, MASING102	FREER, Septumelevator102	HARTMANN, Nasenspekula111
Elevator, McKENTY102,103	FREER, Septumhohlmeißel132	HARTMANN, Polypenzange.....117
Elevator, OBWEGESER149	FREER, Septummeißel128	HARTMANN-HALLE, Nasenspekula .
Elevator, PENNINGTON103	FRIEDMANN, Hohlmeißelzange98110
Elevator, PIERCE103		Hauthäkchen, FRAZIER70
Elevator, REES128	G	Hauthäkchen, ANDERSON79
Elevator, SINUS103	Gaumenspalt-Elevator, BLAIR.106	Hauthäkchen, BARSKY71
Endo-Dissektor, LANGENBECK.....77	Gaumenspalt-Messer, CRONIN ..105	Hauthäkchen, COTTLE88,89
Endo-Dissektor, MINI-LANGENBECK	Gaumenspalter, Raspatorium105	Hauthäkchen, COTTLE-NEIVERT..88
.....77	Gefäßspinzette, STILLE-BARRAYA ...45	Hauthäkchen, FOMON88
Endo-Dissektor77	GERALD, Pinzette43,44	Hauthäkchen, FREER88
Endoskop152	GERZOG, Hammer100	Hauthäkchen, GILLIES89
Ersatzbacken f. Hammer100	Gewebefäßspinzette, SINGLEY45	Hauthäkchen, GRAEFE69
Ersatzklinge f. SCHINK Dermatome...5	GILLIES, Hauthäkchen89	Hauthäkchen, GUTHRIE69
Ersatzklingen f. Dermatomy6	GILLIES, Nadelhalter94	Hauthäkchen, HUMBY71
	GILLIES, Pinzetten43	Hauthäkchen, JOSEPH70
F	GLABELLA, Nasenraspel134	Hauthäkchen, KLEINERT-KUTZ.....70
Face-Lift-Schere, BEUSE31	GOLDMAN-FOX, Zahnfleissschere..29	Hauthäkchen, MT-BRAUN INSTRUMENTE.72
Face-Lift-Schere, GORNEY30	Goniometer, Finger2	Hauthäkchen, TYRELL69
Face-Lift-Schere, GORNEY-FREE-	GORNEY, Dissektor102	HEYMANN, Nasenschere27
MAN30	GORNEY, Face-Lift-Schere30	HEYMANN-KNIGHT, Polypenzange.118
Face-Lift-Schere, KAYE31	GORNEY, Wundhaken81	Hohlmeißel, FREER132
Face-Lift-Schere, PECK-JOSEPH..31	GORNEY-FREEMAN, Face-Lift-	Hohlmeißel, HAJEK132
Fadenpinzette, OCHSNER45	Schere30	Hohlmeißel, KILLIAN130
Fadenschere, LITTAUER28	GRADLE, Schere23	Hohlmeißel, KILLIAN-CLAUS132
Fadenschere, O'BRIEN28	GRAEFE, Hauthäkchen69	Hohlmeißel, WEST132
Fadenschere, SPENCER28	GRAEFE, Irispinzette52	Hohlmeißelzange, BEYER.....98
FARABEUF, Wundhaken65	GRAEFE, Pinzette41	Hohlmeißelzange, BÖHLER98
Faßpinzette, COLLIN-DUVAL42	GRAEFE, Schere22	Hohlmeißelzange, FRIEDMANN98
Faßpinzette, DURANTE45	GRAIG, Septumzange119	HOLZHEIMER, Wundsperrer75
Faßpinzette, DUVAL42	GREEN, Fixierpinzette56	HOWARTH, Septumelevator103
Faßpinzette, RUSS. MODELL42	GREENBERG-PAR, Blepharoplastik	HUMBY, Dermatome6
Faßzange f. plastische Endoskopie.157	Schere.....32	HUMBY, Hauthäkchen71
Faßzange, MARYLAND157	GUILLEN, Saugraspatorium109	
FERRIERA, Wundhaken78	GUTHRIE, Hauthäkchen69	I
FERRIS-SMITH, Pinzette42		IRIS, Schere20
Finger-Goniometer2	H	Irishäkchen, O'CONNOR86
FINSEN, Wundhaken75	HAJEK, Septumhohlmeißel132	Irishäkchen, WIENER86
Fixierpinzette, COTTLE57	HAJEK-BALLENGER, Septumeleva-	Irispinzette, BISHOP-HARMAN53
Fixierpinzette, GREEN56	tor104	Irispinzette, GRAEFE52
Flachmeißel, MINI-LAMBOTTE....132	Hakenschere für plastische En-	
FOERSTER, Kapselmesser127	doskopie.....156	

J	JACKSON, Trachealhaken90	L	LA GRANGE, Zahnfleischschere...26	MEAD, Hammer.....100
JACOBSON Mikro, Arterienklemme...60	JAEGER, Lidplatte.....58	LAHEY, Wundhäkchen.....70	LANDOLT, Skalpellgriff.....12	Meißel, COTTLE.....129
JAMESON, Präparierschere.....19	JANSEN, Wundsperrer.....75	LANGE, Nasenflügelhäkchen.....89	LANGENBECK, Endo-Dissektor...77	Meißel, FREER.....128
JANSEN-GRUENWALD, Ohrpinzette.....57	JENNINGS, Mundsperrer.....141	LANGENBECK, Raspator.....101	LANGENBECK, Raspator.....101	Meißel, KILLIAN.....130
J-Haken Elektrode, monopolar.....158	J-SEPHER, Nasenmesser.....124,125	LERICHE, Pinzette.....41	LERICHE, Arterienklemme.....63	Meißel, MINI-LAMBOTTE.....132
JOSEPH (LEWIS), Nasenraspel...135	JOSEPH, Hauthäkchen.....70	LEXER, Präparierschere.....15	LEXER, Präparierschere.....15	Meißel, SILVER.....130
JOSEPH, Hauthäkchen.....70	JOSEPH, Nasenmesser.....124,125	LEXER BABY, Präparierschere.....15	LITTAUER, Fadenschere.....28	Meßinstrument, CASTROVIEJO.....4
JOSEPH, Nasenraspel.....134	JOSEPH, Nasensäge.....138,139	LITTLER, Schere.....22	LITTLER, Schere.....22	Meßinstrument, COLLIER.....4
JOSEPH, Nasensäge.....138,139	JOSEPH, Präparierschere.....18	LOCKWOOD, Markierungsinstrument...3	LOCKWOOD, Markierungsinstrument...3	Meßzirkel, CASTROVIEJO.....4
JOSEPH, Präparierschere.....18	JOSEPH, Raspator.....101	LUBET-BARBON, Nasentamponzange.....117	LUBET-BARBON, Nasentamponzange.....117	Metallmaßstab.....2
JOSEPH, Raspator.....101	JOSEPH, Septumlevator.....102	LUC, Septumzange.....119	LUC, Septumzange.....119	METZENBAUM, Präparierschere...16,17
JOSEPH, Septumlevator.....102	JOST, Knorpelquetscher.....133	LUCAE, Ohrpinzette.....57	LUCAE, Ohrpinzette.....57	METZENBAUM, Schere für plastische Endoskopie.....156
JOST, Knorpelquetscher.....133		MacCOLLUM-DINGMAN, Brustdissektor.....83	MacCOLLUM-DINGMAN, Brustdissektor.....83	METZENBAUM-FINO, Präparierschere.....17
K	Kapselmesser, FOERSTER.....127	M	MALINIAC, Nasenhaken.....87	MEYERDING, Wundhaken.....74
KASDEN, Wundhaken.....73	KAYE, Blepharoplastik-Schere.....32	MALTZ (COTTLE), Nasenraspel...135	MALTZ (COTTLE), Nasenraspel...135	Micro HARTMANN, Arterienklemme...59
KAYE, Face-Lift-Schere.....31	KAYE, Face-Lift-Schere.....31	MALTZ, Nasenraspel.....134	MALTZ, Nasenraspel.....134	MICROVASCULAR, Nadelhalter...93
KELLY, Arterienklemme.....61	KELLY, Präparierschere.....19	Markierungsinstrument, D'ASSUMPACO.....3	Markierungsinstrument, FREEMAN.....4	MIDDLETON-JANSEN, Septumzange.....123
KELLY, Präparierschere.....19	KELLY-RANKIN, Arterieklemme.....61	Markierungsinstrument, FREEMAN.....4	Markierungsinstrument, LOCKWOOD...3	Septumzange.....123
KILLIAN, Hohlmeißel.....130	KILLIAN, Nasenspekula.....113,114	Markierungsinstrument, LOCKWOOD...3	Markierungsinstrument, LOCKWOOD...3	Mikro Knüpfpinzette.....47
KILLIAN, Nasenspekula.....113,114	KILLIAN, Septumlevator.....103,104	Markierungsinstrument, McKISSOCK.....4	Markierungsinstrument, McKISSOCK.....4	Mikro Ringpinzetten.....48
KILLIAN, Septumlevator.....103,104	KILLIAN-CLAUS, Septumhohlmeißel...132	Markierungsinstrument, PITANGUY.....3	Markierungsinstrument, PITANGUY.....3	Mikro Nadelhalter, CASTROVIEJO...96
KILLIAN-CLAUS, Septumhohlmeißel...132	KILNER, Nasenhaken.....88	MARTINEZ-KILNER, Wundhaken...89	MARTINEZ-KILNER, Wundhaken...89	Mikro Pinzette.....43
KILNER, Nasenhaken.....88	KILNER, Präparierschere.....19	MARYLAND, Faßzange für plastische Endoskopie.....157	MARYLAND, Faßzange für plastische Endoskopie.....157	Mikro Schere.....33,34,35
KILNER, Präparierschere.....19	KILNER-DOUGHTY, Mundsperrer...143	MASING, Elevator.....102	MASING, Elevator.....102	MILLER, Wundhäkchen.....86
KILNER-DOUGHTY, Mundsperrer...143	KILNER-DOUGHTY, Zungenspatel...143	MASING-NEIVERT, Nasenhaken...87	MASING-NEIVERT, Nasenhaken...87	MINI, Skalpellgriff.....10
KILNER-DOUGHTY, Zungenspatel...143	KLAPP, Wundhaken.....72	Maßstab, Metall.....2	Maßstab, Metall.....2	MINI, Skalpellklingen.....10
KLAPP, Wundhaken.....72	KLEINERT-KUTZ, Hauthäkchen...70	MAYO, Präparierschere.....13	MAYO, Präparierschere.....13	MINI-LAMBOTTE, Flachmeißel...132
KLEINERT-KUTZ, Hauthäkchen...70	KNAPP, Schere.....21	MAYO-HABERISSER, TC-Drahtzange.....97	MAYO-HABERISSER, TC-Drahtzange.....97	MINI-LANGENBECK, Endo-Dissektor...77
KNAPP, Schere.....21	KNAPP, Tränensackhäkchen.....86	MAYO-HEGAR, Nadelhalter.....92	MAYO-HEGAR, Nadelhalter.....92	Mobilisierhaken, TESSIER.....150
KNAPP, Tränensackhäkchen.....86	KNIGHT, Septumzange.....118	MAYO-STILLE, Präparierschere...14	MAYO-STILLE, Präparierschere...14	MOD. BONN, Nahtpinzette.....54
KNIGHT, Septumzange.....118	Knochensplitterzange, BÖHLER...99	McINDOE, Knochensplitterzange...99	McINDOE, Knochensplitterzange...99	MOD. TUEBINGEN, Nahtpinzette...54
Knochensplitterzange, BÖHLER...99	Knochensplitterzange, COTTLE-KAZANJIAN.....99	McINDOE, Knorpelschere.....29	McINDOE, Knorpelschere.....29	MOD. WIEN, Nasenspekula.....112
Knochensplitterzange, COTTLE-KAZANJIAN.....99	Knorpelquetscher, COTTLE.....133	McINDOE, Pinzetten.....42	McINDOE, Pinzetten.....42	MOELTGEN, Winkelmesser.....2
Knorpelquetscher, COTTLE.....133	Knorpelquetscher, JOST.....133	McIVOR, Mundsperrer.....144	McIVOR, Mundsperrer.....144	Monopolare J-Haken-Elektrode...158
Knorpelquetscher, JOST.....133	Knorpelschere, McINDOE.....29	McIVOR, Bügel.....144	McIVOR, Bügel.....144	Monopolare Spatel-Elektrode.....158
Knorpelschere, McINDOE.....29	Knüpfpinzette, Mikro.....47	McIVOR, Zungenspatel.....144	McIVOR, Zungenspatel.....144	Mukosamesser, FREER.....124
Knüpfpinzette, Mikro.....47		McKENTY, Septumlevator...102,103	McKENTY, Septumlevator...102,103	Mundsperrer, DAVIS-BOYLE.....142
		McKISSOCK, Markierungsinstrument...4	McKISSOCK, Markierungsinstrument...4	Mundsperrer, DAVIS-MEYER.....144
				Mundsperrer, DINGMANN.....143
				Mundsperrer, JENNINGS.....141
				Mundsperrer, KILNER-DOUGHTY...143
				Mundsperrer, McIVOR.....144
				Muskelpinzette, BERKE.....55
				MYLES, Nasenzange.....121

N	Nasentamponzange, LUBET-BAR-BON117	Pinzette, BERKE55
Nadelhalter, BABY OLSEN-HEGAR...93	Nasentamponzange, WESTMACOTT117	Pinzette, BISHOP-HARMAN53
Nadelhalter, BABY WEBSTER91	Nasenzange, CAPLAN122	Pinzette, BONNEY45
Nadelhalter, BARRAQUER95	Nasenzange, MYLES121	Pinzette, BROWN41
Nadelhalter, BAUMGARTNER92	Nasenzange, SCHMEDEN121	Pinzette, CASTROVIEJO55
Nadelhalter, CRILE-WOOD92	Nasenzange, TAKAHASHI121	Pinzette, chirurgisch37
Nadelhalter, DeBAKEY92	Nasenzange, WEIL-BLAKESLEY120	Pinzette, COLLIN-DUVAL42
Nadelhalter, DERF91	NEIVERT-ANDERSON, Osteotom...130	Pinzette, COTTLE57
Nadelhalter, GILLIES94	Nervhaken77	Pinzette, CUSHING41
Nadelhalter, HALSEY91	Nervhaken, CRILE85	Pinzette, DeBAKEY48,50,51
Nadelhalter, MAYO-HEGAR92	Nervhaken, CUSHING85	Pinzette, DESMARRES55
Nadelhalter, MICROVASCULAR93	NEWS, Trachealhaken90	Pinzette, DURANTE45
Nadelhalter, Mikro, Titan95	O	Pinzette, DUVAL42
Nadelhalter, OLSEN-HEGAR93	O'BRIEN, Fadenschere28	Pinzette, FERRIS-SMITH42
Nadelhalter, RYDER93	OBWEGESER, Osteotom131	Pinzette, GERALD43,44
Nadelhalter, WEBSTER91	OBWEGESER, Raspator149	Pinzette, GILLIES43
Nahtpinzette, CASTROVIEJO55	OBWEGESER, Wundhaken	Pinzette, GRAEFE41,52
Nahtpinzette, MOD. BONN.54	146,147,148	Pinzette, GREEN56
Nahtpinzette, MOD. TUEBINGEN ..54	OCHSNER, Fadenpinzette45	Pinzette, JANSEN-GRUENWALD ..57
Nasenflügelhäkchen, LANGE89	O'CONNOR, Irishäkchen86	Pinzette, LERCHE41
Nasenhaken, AUFRICHT87	OEHLER, chirurgische Pinzette...37	Pinzette, LUCAE57
Nasenhaken, CONVERSE87,89	Ohrpinzette, JANSEN-GRUENWALD ..57	Pinzette, McINDOE42
Nasenhaken, COTTLE87	Ohrpinzette, LUCAE57	Pinzette, MOD. BONN.54
Nasenhaken, KILNER88	Ohrpinzette, TROELTSCH57	Pinzette, MOD. TUEBINGEN54
Nasenhaken, MALINIAC87	Ohrpinzette, WILDE (TROELTSCH)...57	Pinzette, OCHSNER45
Nasenhaken, MASING-NEIVERT...87	OLSEN-HEGAR, Nadelhalter93	Pinzette, OEHLER37
Nasenmesser, CONVERSE125	Opthalmologie Schere23	Pinzette, POTTS-SMITH36
Nasenmesser, COTTLE125	Optik f. plastische Endoskopie...152	Pinzette, RUSS. MODELL42
Nasenmesser, JOSEPH124,125	Osteotom151	Pinzette, SEMKEN43
Nasenraspel, AUFRICHT135	Osteotom, COTTLE129	Pinzette, SINGLEY45
Nasenraspel, DINGMAN138	Osteotom, NEIVERT-ANDERSON...130	Pinzette, STILLE36,37
Nasenraspel, FOMON136,137	Osteotom, OBWEGESER131	Pinzette, STILLE-BARRAYA.....45
Nasenraspel, GLABELLA134	Osteotom, RUBIN129	Pinzette, TAYLOR44
Nasenraspel, JOSEPH134	Osteotom, TESSIER151	Pinzette, TROELTSCH57
Nasenraspel, JOSEPH (LEWIS)...135	Osteotom, WEST132	Pinzette, USA36,37
Nasenraspel, MALTZ134	P	Pinzette, WAUGH41
Nasenraspel, MALTZ (COTTLE)..135	PARKES, Nasenraspel134	Pinzette, WILDE (TROELTSCH)....57
Nasenraspel, PARKES134	PARTSCH, Hammer100	PITANGUY, Markierungsinstrument3
Nasenraspel, PEET134	PECK-JOSEPH, Face-Lift-Schere .31	Polypenzange, HARTMANN117
Nasensäge, JOSEPH138,139	PEET, Nasenraspel134	Polypenzange, HEYMANN-KNIGHT 118
Nasenschere, COTTLE27	PENNINGTON, Septumelevator...103	POTTS-SMITH, Pinzette36
Nasenschere, COTTLE-MASING...27	PIERCE, Septumelevator103	Präparierschere, JAMESON.....19
Nasenschere, FOMON27	Pinzette, CUSHING (TAYLOR)....44	Präparierschere, JOSEPH18
Nasenschere, HEYMANN27	Pinzette, ADSON38,39	Präparierschere, KELLY19
Nasenspekula, HARTMANN-HALLE..110	Pinzette, ADSON-BROWN40	Präparierschere, KILNER19
Nasenspekula, COTTLE115,116	Pinzette, anatomisch36	Präparierschere, LEXER15
Nasenspekula, HARTMANN111	Pinzette, BARRAQUER55	Präparierschere, LEXER BABY15
Nasenspekula, KILLIAN113,114	Pinzette, BEASELEY BABCOCK ...39	Präparierschere, MAYO13
Nasenspekula, Mod. WIEN112		Präparierschere, MAYO-STILLE....14
Nasenspekula, MT-BRAUN INSTRUMENTE		Präparierschere, METZENBAUM
Nasenspekula, TIECK-HALLE112	16,17

Präparierschere,
 METZENBAUM FINO17
 Präparierschere, RAGNELL19
 Präparierschere, REYNOLDS19
 Präparierschere, SANVENERO.....18
 PROVIDENCE-HOSPITAL, Arterien-
 klemme.....61

Q

QUISLING, Hammer100

R

RAGNELL, Präparierschere19
 RAGNELL, Wundhaken65
 RAMUS, Wundhaken148
 Rasierklingen, unsteril6
 Raspator, DINGMANN150
 Raspator, FOMON101
 Raspator, JOSEPH101
 Raspator, LANGENBECK101
 Raspator, OBWEGESER149
 Raspator, WILLIGER101
 Raspatorium, Gaumenspalter.....105
 Rospel, AUFRICHT135
 Rospel, DINGMAN138
 Rospel, FOMON136,137
 Rospel, JOSEPH (LEWIS)135
 Rospel, MALTZ (COTTLE)135
 Rospel, PARKES134
 Rospel, PEET134
 Rospel, WIENER134
 MT-BRAUN INSTRUMENTE, Hauthäkchen12
 MT-BRAUN INSTRUMENTE, Nasenspekulum12
 MT-BRAUN INSTRUMENTE, Sichelmesser125
 REES, Elevator128
 REYNOLDS, Präparierschere19
 RIBBON, Darmspatel66
 Ringpinzette, Mikro49
 ROCHESTER-OCHSNER, Ar-
 terienklemme.....63
 ROCHESTER-PEAN, Arterien-
 klemme.....63
 ROLLET, Tränensackhäkchen86
 ROUX MINI, Wundhaken65
 RUBIN, Osteotom129
 RUBIN, Septumzange122
 RUSS. MODELL, Fußpinzette42
 RUSSEL-DAVIS, Zungenspatel.....145
 RYDER, Nadelhalter93

S

SANVENERO, Präparierschere.....18
 Saugraspatorium, GUILLEN109
 Saugrohr, ADSON107
 Saugrohr, FRAZIER/FERGUSSON ..108
 Saugrohr, BARON107
 Schaff f. plastische Endoskopie
153,154,155
 Schere f. plastische Endoskopie ..156
 Schere, BEUSE31
 Schere, BONN20
 Schere, CHADWICK26
 Schere, CONVERRSE/WILMER22
 Schere, COTTLE22,27
 Schere, COTTLE-MASING27
 Schere, FOMON27
 Schere, GOLDMAN-FOX29
 Schere, GORNEY30
 Schere, GORNEY-FREEMAN30
 Schere, GRADLE23
 Schere, GRAEFE22
 Schere, GREENBERG-PAR32
 Schere, HEYMANN27
 Schere, IRIS20
 Schere, JAMESON19
 Schere, JOSEPH18
 Schere, KAYE31,32
 Schere, KELLY19
 Schere, KILNER19
 Schere, KNAPP21
 Schere, LA GRANGE26
 Schere, LEXER15
 Schere, LEXER BABY15
 Schere, LITTAUER28
 Schere, LITTLER22
 Schere, MAYO13
 Schere, MAYO-STILLE14
 Schere, McINDOE29
 Schere, METZENBAUM16,17
 Schere, METZENBAUM-FINO17
 Schere, Mikro33,34,35
 Schere, O'BRIEN28
 Schere, Ophtalmologie23
 Schere, PECK-JOSEPH31
 Schere, RAGNELL19
 Schere, REYNOLDS19
 Schere, SANVENERO18
 Schere, SPENCER28
 Schere, STEVENS24
 Schere, STRABISMUS24
 Schere, WAGNER25
 SCHINK, Dermatome5

SCHMEDEN, Nasenzange121
 Schwingmesser, BALLENGER.....126
 SEMKEN, Pinzetten43
 Septumelevator, BALLENGER.....104
 Septumelevator, COTTLE.....103,104
 Septumelevator, COTTLE-JOSEPH .
103
 Septumelevator, FREER102
 Septumelevator, HAJEK-BAL-
 LINGER104
 Septumelevator, HOWARTH103
 Septumelevator, JOSEPH102
 Septumelevator, KILLIAN103,104
 Septumelevator, McKENTY...102,103
 Septumelevator, PENNINGTON...103
 Septumelevator, PIERCE103
 Septumelevator, SINUS103
 Septumhohlmeißel, FREER132
 Septumhohlmeißel, HAJEK132
 Septumhohlmeißel, KILLIAN-CLAUS .
132
 Septummeißel, COTTLE129
 Septummeißel, FREER128
 Septummeißel, SILVER130
 Septumosteotom, COTTLE129
 Septumrichtzange, ASCH140
 Septumrichtzange, WALSHAM ...140
 Septumzange, BRUENINGS119
 Septumzange, GRAIG119
 Septumzange, KNIGHT118
 Septumzange, LUC119
 Septumzange, MIDDLETON-
 JANSEN123
 Septumzange, RUBIN122
 Sichelmesser, MT-BRAUN INSTRUMENTE .125
 Silikon-Schlauch144
 SILVER, Dermatome6
 SILVER, Septummeißel130
 SILVERSTEIN, Brustdissektor83
 SINGLEY, Gewebefußpinzette45
 SINUS, Septumelevator103
 Skalpellgriff, LANDOLT12
 Skalpellgriff, Mini10
 Skalpellklingen, Mini10
 Skalpellklingen, steril11
 Skalpellklingen-Entferner11
 Spannplatte5
 Spatel80
 Spatel-Elektrode, monopolar158
 SPENCER, Fadenschere28
 Sperrer, DAVIS-BOYLE142
 Sperrer, DINGMANN143

Sperrer, KILNER-DOUGHTY143
 SPINA-NASALIS, Wundhaken148
 Splitterpinzetten46
 Stahlhammer, COTTLE100
 STEVENS, Schere24
 STILLE, Pinzette36,37
 STILLE-BARRAYA, Gefäßpinzette45
 STRABISMUS, Schere24
 STRANDELL-STILLE, Wundhaken74

T

TAKAHASHI, Nasenzange121
 Tamponzange, LUBET-BARBON117
 Tamponzange, WESTMACOTT117
 TAYLOR, Pinzette44
 TC-Drahtzange, BERRY97
 TC-Drahtzange, MAYO-HABERISS-
 ER97
 TC-Nasenraspel, FOMON137
 TC-Nasenraspel, MALTZ (COTTLE) 135
 TEBBETTS, Brustdissektor83
 TEBBETTS, Wundhaken78
 TESSIER, Mobilisierhaken150
 TESSIER, Osteotom151
 TIECK-HALLE, Nasenspekula112
 Titan Mikro Nadelhalter95,96
 Trachealhaken, JACKSON90
 Trachealhaken, NEWS90
 Tränensackhäkchen, KNAPP86
 Tränensackhäkchen, ROLLET86
 TROELTSCH, Ohrpinzette57
 TYRELL, Hauthäkchen69

U

Uhrmacherpinzette46
 USA, Pinzette36,37

V

VOLKMANN, Wundhaken73

W

WAGNER, Schere25
 WALSHAM, Septumrichtzange140
 WATSON, Dermatome6
 WAUGH, Pinzette41
 WEBSTER, Nadelhalter91
 WEIL-BLAKESLEY, Nasenzange120
 WEITLANER, Wundsperrer76
 WEST, Hohlmeißel132
 WEST, Osteotom132
 WESTMACOTT, Nasentamponzange
117

WIEDER, Zungenspatel141
 WIENER, Antrumraspel134
 WIENER, Irishäkchen86
 WILDE (TROELTSCH), Ohrpinzette...57
 WILLIGER, Raspator101
 Winkelmesser, MOELTGEN2
 Wundhäkchen, BARSKY71
 Wundhäkchen, COTTLE88,89
 Wundhäkchen, COTTLE-NEIVERT...88
 Wundhäkchen, FOMON88
 Wundhäkchen, FREER88
 Wundhäkchen, GILLIES89
 Wundhäkchen, HUMBLY71
 Wundhäkchen, KNAPP86
 Wundhäkchen, LAHEY70
 Wundhäkchen, MILLER86
 Wundhäkchen, O'CONNOR86
 Wundhäkchen, ROLLET86
 Wundhäkchen, WIENER86
 Wundhaken150
 Wundhaken, ALM75
 Wundhaken, ANDERSON79
 Wundhaken, BIGGS84
 Wundhaken, BREAST79
 Wundhaken, CORONAL79
 Wundhaken, CRILE65
 Wundhaken, DEEVER67
 Wundhaken, DESMARRES73
 Wundhaken, FARABEUF65
 Wundhaken, FERRIERA78
 Wundhaken, FINSEN75
 Wundhaken, FREEMAN68,79,81
 Wundhaken, GORNEY81
 Wundhaken, KASDEN73
 Wundhaken, KLAPP72
 Wundhaken, MARTINEZ-KILNER89
 Wundhaken, MEYERDING74
 Wundhaken, OBWEGESER
146,147,148
 Wundhaken, RAGNELL65
 Wundhaken, RAMUS148
 Wundhaken, ROUX MINI65
 Wundhaken, SPINA-NASALIS148
 Wundhaken, STRANDELL-STILLE...74
 Wundhaken, TEBBETTS78
 Wundhaken, VOLKMANN73
 Wundhaken, YANKOSKIE79
 Wundsperrer, HOLZHEIMER75
 Wundsperrer, WEITLANER76
 Wundsperrer, JANSEN75

Y

YANKOSKIE, Wundhaken79

Z

Zahnfleischschere, CHADWICK26
 Zahnfleischschere, GOLDMAN-FOX .
29
 Zahnfleischschere, LA GRANGE...26
 Zungenspatel, ANDREW141
 Zungenspatel, DAVIS-BOYLE142
 Zungenspatel, DINGMANN143
 Zungenspatel, KILNER-DOUGHTY .
143
 Zungenspatel, McIVOR144
 Zungenspatel, RUSSEL-DAVIS...145
 Zungenspatel, WIEDER141

A	C	D
ADSON, dressing forceps38	caliper, CASTROVIEJO4	D'ASSUMPACO, facelift marker3
ADSON, tissue forceps.....38, 39	CAPLAN, nasal cutting forceps122	DAVIS-BOYLE, mouth gag142
ADSON, forceps64	cartilage crusher, COTTLE133	DAVIS-MEYER, mouth gag144
ADSON, hook85	cartilage crusher, JOST133	DEAVER, retractor67
ADSON, suction tube107	CASTROVIEJO, caliper.....4	DeBAKEY, atrauma forceps...49, 50, 51
ADSON-BROWN, tissue forceps...40	CASTROVIEJO, suture forceps55	DeBAKEY, needle holder92
ADSON-DeBAKEY, dressing forceps38	CASTROVIEJO, needle holder96	DERF, needle holder91
AGRIS-DINGMAN, dissector.....82	CHADWICK, scissors26	dermatome, HUMBY6
ALM, retractor75	chalazion forceps, DESMARRES...55	dermatome, SCHINK5
ANDERSON, retractor79	chisel, COTTLE129	dermatome, SILVER6
ANDREW, tongue depressor.....141	chisel, WEST132	dermatome, WATSON6
ASCH, septum straightening forceps140	cilia forceps, BARRAQUER.....55	DESMARRES, chalazion forceps...55
atrauma forceps, DeBAKEY ..49, 50, 51	COLLER-CRILE, forceps61	DESMARRES, retractor73
AUFRICHT, retractor87	COLLIER, pelvimeter4	DINGMAN, nasal rasp138
AUFRICHT, nasal rasp135	COLLIN-DUVAL, tissue forceps.....42	DINGMANN, mouth gag143
	columella forceps, COTTLE57	DINGMANN, elevator150
	CONVERSE, retractor87	dissector, AGRIS-DINGMAN82
B	CONVERSE, retractor89	dissector, GORNEY102
BABY OLSEN-HEGAR, needle holder93	CONVERSE, knife125	dissector, LANGENBECK77
BALLENGER, elevator104	CONVERSE/WILMER, scissors22	dissector, LANGENBECK-COTTLE77
BALLENGER, knife126	CORONAL, retractor79	dissector, MacCOLLUM-DINGMAN ..83
BARON, suction tube107	COTTLE, scissors22, 27	dissector, MINI-LANGENBECK.....77
BARRAQUER, cilia forceps55	COTTLE, ear forceps57	dissector, SILVERSTEIN83
BARRAQUER, needle holder95	COTTLE, columella forceps57	DOLPHIN, endoscopic grasper157
BARSKY, retractor71	COTTLE, retractor87, 88, 89	dressing, forceps36, 37, 43
BAUMGARTNER, needle holder...92	COTTLE, mallet100	dressing forceps, ADSON38
BEASELEY BABCOCK, tissue forceps39	COTTLE, elevator.....103, 104	dressing forceps, ADSON- DeBAKEY38
BERKE, muscle forceps55	COTTLE, nasal specula.....115, 116	dressing forceps, CUSHING-TAY- LOR44
BERRY, wire twisting forceps97	COTTLE, knife125	dressing forceps, GERALD43, 44
BEUSE, scissors31	COTTLE, osteotome129	dressing forceps, McINDOE42
BEYER, rongeur98	COTTLE, chisel129	dressing forceps, OCHSNER45
BIGGS, retractor84	COTTLE, cartilage crusher.....133	dressing forceps, POTTS-SMITH...36
BISHOP-HARMAN, iris forceps53	COTTLE JOSEPH, elevator103	dressing forceps, SEMKEN43
blades, scalpel11	COTTLE-KAZANJIAN, bone cutting forceps99	dressing forceps, SINGLEY45
BLAIR, lip and cleft palate instru- ment106	COTTLE-MASING, scissors27	dressing forceps, STILLE36
BÖHLER, rongeur98	COTTLE-NEIVERT, retractor.....88	dressing forceps, TAYLOR44
BÖHLER, bone cutting forceps99	CRILE, forceps62	dressing forceps, USA36
BOIES, elevator102	CRILE, hook85	DURANTE, tissue forceps45
bone cutting forceps, BÖHLER99	CRILE-RANKIN, forceps62	DUVAL, tissue forceps42
bone cutting forceps, COTTLE- KAZANJIAN99	CRILE-WOOD, needle holder92	
bone cutting forceps, MC INDOE ...99	CRONIN, lip and cleft palate instru- ment105	E
BONN, scissors20	CUSHING, hook85	ear forceps, COTTLE57
BONNEY, tissue forceps45	CUSHING, tissue forceps41	ear forceps, JANSEN-GRUENWALD57
BREAST, retractor79	CUSHING-TAYLOR, dressing forceps44	ear forceps, LUCAE57
breast, spatula80		ear forceps, TROELTSCH57
BROWN, tissue forceps41		ear polypus forceps, HARTMANN117
BRUENINGS, septum forceps119		elevator, BALLENGER104

elevator, BOIES	102	forceps, KELLY	61	GUTHRIE, retractor	69
elevator, COTTLE	103, 104	forceps, KELLY-RANKIN	61	H	
elevator, COTTLE JOSEPH	103	forceps, LERICHE	63	HAJEK, gouge	132
elevator, DINGMANN	150	forceps, micro suture tying	47	HAJEK-BALLENGER, elevator	104
elevator, FREER	102	forceps, micro ring	48	HALSEY, needle holder	91
elevator, FREER	128	forceps, MICRO-HARTMANN	59	HALSTED-MOSQUITO, forceps	60
elevator, HAJEK-BALLENGER	104	forceps, PROVIDENCE-HOSPITAL	61	handles, scalpel	7, 8, 9, 10, 12
elevator, HOWARTH	103	forceps, ROCHESTER-OCHSNER	63	HARTMANN, forceps	59
elevator, JOSEPH	102	forceps, ROCHESTER-PEAN	63	HARTMANN, nasal specula	111
elevator, KILLIAN	103, 104	forceps, splinter	46	HARTMANN, ear polypus forceps	117
elevator, LANGENBECK	101	forceps, tissue	36, 37	HARTMANN-HALLE,	
elevator, MASING	102	FRAZIER/FERGUSSON,		nasal specula	110
elevator, McKENTY	102, 103	suction tube	108	heavy grasper, endoscopic	157
elevator, OBWEGESER	149	FREEMAN, marker	4	HEYMAN, scissors	27
elevator, PENNINGTON	103	FREEMAN, retractor	68, 79, 81	HEYMANN-KNIGHT,	
elevator, PIERCE	103	FREER, retractor	88	nasal forceps	118
elevator, REES	128	FREER, elevator	102	HOLZHEIMER, retractor	75
elevator, WILLIGER	101	FREER, knife	124	hook, ADSON	85
endoscope, plastic surgery	153	FREER, elevator	128	hook, CRILE	85
endoscope shaft,		FREER, gouge	132	hook, CUSHING	85
plastic surgery	153, 154, 155	FRIEDMANN, rongeur	98	hook, JACKSON	90
endoscopic, heavy grasper	157	FRIEDMANN MINI, rongeur	98	hook, nerve	77
endoscopic, hook scissors	156	G		hook, NEWS	90
endoscopic grasper, DOLPHIN	157	GERALD, dressing forceps	43, 44	hook scissors, endoscopic	156
endoscopic grasper, MARYLAND	157	GERALD, tissue forceps	44	HOWARTH, elevator	103
endoscopic scissors, METZENBAUM	156	GERZOG, mallet	100	HUMBY, dermatome	6
F		GILLIES, tissue forceps	43	HUMBY, retractor	71
facelift marker, D'ASSUMPACO	3	GILLIES, retractor	89	I	
facelift marker, LOCKWOOD	3	GILLIES, needle holder	94	IRIS, scissors	20
facelift marker, PITANGUY	3	GABELLA, nasal rasp	134	iris forceps, BISHOP-HARMAN	53
FARABEUF, retractor	65	GOLDMAN-FOX, scissors	29	iris forceps, GRAEFE	52
FERRIERA, retractor	78	goniometer, finger	2	J	
FERRIS-SMITH, tissue forceps	42	goniometer, MOELTGEN	2	JACKSON, hook	90
finger, goniometer	2	GORNEY, scissors	30	JAEGER, lid plate	58
FINSEN, retractor	75	GORNEY, retractor	81	JANSEN, retractor	75
fixation forceps, GREEN	56	GORNEY, dissector	102	JANSEN-GRUENWALD,	
FOERSTER, knife	127	GORNEY-FREEMAN, scissors	30	ear forceps	57
FOMON, scissors	27	gouge, FREER	132	JENNINGS, tongue depressor	141
FOMON, retractor	88	gouge, HAJEK	132	J-Hook electrode, monopolar	158
FOMON, raspatory	101	gouge, KILLIAN	130	JOSEPH, scissors	18
FOMON, nasal rasp	136, 137	gouge, KILLIAN-KLAUS	132	JOSEPH, retractor	70
FOMON, nasal rasp	137	gouge, WEST	132	JOSEPH, raspatory	101
forceps, ADSON	64	GRADLE, scissors	23	JOSEPH, elevator	102
forceps, COLLER-CRILE	61	GRAEFE, scissors	22	JOSEPH, knife	124, 125
forceps, CRILE	62	GRAEFE, tissue forceps	41	JOSEPH, nasal rasp	134
forceps, CRILE-RANKIN	62	GRAEFE, iris forceps	52	JOSEPH, nasal saw	138, 139
forceps, dressing	36, 37, 43	GRAEFE, retractor	69	JOSEPH (LEWIS), nasal rasp	135
forceps, HALSTED-MOSQUITO	60	GRAIG, septum forceps	119	JOST, cartilage crusher	133
forceps, HARTMANN	59	GREEN, fixation forceps	56		
		GREENBERG-PAR, scissors	32		
		GUILEN, suction tube	109		

K		M	
KASDAN, retractor	73	MacCOLLUM-DINGMAN, dissector	83
KAYE, scissors	31, 32	MALINIAC, retractor	87
KELLY, scissors	19	mallet, COTTLE	100
KELLY, forceps	61	mallet, GERZOG	100
KELLY-RANKIN, forceps	61	mallet, MEAD	100
KILLIAN, elevator	103, 104	mallet, nylon cap	100
KILLIAN, nasal specula	113, 114	mallet, PARTSCH	100
KILLIAN, gouge	130	mallet, QUISLING	100
KILLIAN-KLAUS, gouge	132	MALTZ, nasal rasp	134
KILNER, scissors	19	MALTZ (COTTLE), nasal rasp	135
KILNER, retractor	88	marker, FREEMAN	4
KILNER-DOUGHTY, mouth gag	143	marker, McKISSOCK	4
KLAPP, retractor	72	MARYLAND, endoscopic grasper	157
KLEINERT-KUTZ, retractor	70	MASING, elevator	102
KNAPP, scissors	21	MASING-NEIVERT, retractor	87
KNAPP, retractor	86	MAYO, scissors	13
knife, BALLENGER	126	MAYO-HABERISSER, wire	
knife, CONVERSE	125	twisting forceps	97
knife, COTTLE	125	MAYO-HEGAR, needle holder	92
knife, FOERSTER	127	MAYO-STILLE, scissors	14
knife, FREER	124	MC INDOE, scissors	29
knife, JOSEPH	124, 125	MC INDOE, bone cutting forceps	99
knife, MT-BRAUN INSTRUMENTE	125	McINDOE, tissue forceps	42
KNIGHT, nasal forceps	118	McINDOE, dressing forceps	42
		McIVOR, mouth gag	144
L		McKENTY, elevator	102, 103
LA GRANGE, scissors	26	McKISSOCK, marker	4
LAHEY, retractor	70	MEAD, mallet	100
LANGE, retractor	89	metal, ruler	2
LANGENBECK, dissector	77	METZENBAUM, scissors	16, 17
LANGENBECK, elevator	101	METZENBAUM,	
LANGENBECK-COTTLE, dissector	77	endoscopic scissors	156
LERCHE, tissue forceps	41	METZENBAUM-FINO, scissors	17
LERICHE, forceps	63	MEYERDING, retractor	74
LEXER, scissors	15	micro, scissors	33, 34, 35
LEXER-BABY, scissors	15	micro suture tying, forceps	47
lid plate, JAEGER	58	micro ring, forceps	48
lip and cleft palate instrument,	105	MICRO-HARTMANN, forceps	59
lip and cleft palate instrument, BLAIR		MICROVASCULAR, needle holder	93
.....	106	MIDDLETON-JANSEN,	
lip and cleft palate instrument,		septum forceps	123
CRONIN	105	MILLER, retractor	86
LITTAUER, scissors	28	MINI-LAMBOTTE, osteotome	132
LITTLER, scissors	22	MINI-LANGENBECK, dissector	77
LOCKWOOD, facelift marker	3	MOD. BONN, suture forceps	54
LUBET-BARBON, nasal forceps	117	MOD. TUEBINGEN, suture forceps	54
LUC, septum forceps	119	Mod. WIEN, nasal specula	112
LUCAE, ear forceps	57	MOELTGEN, goniometer	2
		monopolar, J-Hook electrode	158
		monopolar, Spatula electrode	158
		mouth gag, DAVIS-BOYLE	142
		mouth gag, DAVIS-MEYER	144
		mouth gag, DINGMANN	143
		mouth gag, KILNER-DOUGHTY	143
		mouth gag, McIVOR	144
		muscle forceps, BERKE	55
		MYLES, nasal cutting forceps	121
		N	
		nasal cutting forceps, CAPLAN	122
		nasal cutting forceps, MYLES	121
		nasal cutting forceps, SCHMEDEN	121
		nasal cutting forceps,	
		TAKAHASHI	121
		nasal cutting forceps, WEIL-	
		BLAKESLEY	120
		nasal forceps, HEYMAN-KNIGHT	118
		nasal forceps, KNIGHT	118
		nasal forceps, LUBET-BARBON	117
		nasal forceps, WESTMACOTT	117
		nasal rasp, AUFRICHT	135
		nasal rasp, DINGMAN	138
		nasal rasp, FOMON	136, 137
		nasal rasp, FOMON	137
		nasal rasp, GLABELLA	134
		nasal rasp, JOSEPH	134
		nasal rasp, JOSEPH (LEWIS)	135
		nasal rasp, MALTZ	134
		nasal rasp, MALTZ (COTTLE)	135
		nasal rasp, PARKES	134
		nasal rasp, PEET	134
		nasal rasp, WIENER	134
		nasal rasp, wire brush	138
		nasal saw, JOSEPH	138, 139
		nasal specula, COTTLE	115, 116
		nasal specula, HARTMANN	111
		nasal specula, HARTMANN-HALLE	110
		nasal specula, KILLIAN	113, 114
		nasal specula, Mod. WIEN	112
		nasal specula, MT-BRAUN INSTRUMENTE	112
		nasal specula, TIECK-HALLE	112
		needle holder,	
		BABY OLSEN-HEGAR	93
		needle holder, BARRAQUER	95
		needle holder, BAUMGARTNER	92
		needle holder, CASTROVIEJO	96
		needle holder, CRILE-WOOD	92
		needle holder, DeBAKEY	92
		needle holder, DERF	91
		needle holder, GILLIES	94

needle holder, HALSEY91
 needle holder, MAYO-HEGAR92
 needle holder, MICROVASCULAR93
 needle holder, OLSEN-HEGAR.93
 needle holder, RYDER93
 needle holder, WEBSTER91
 NEIVERT-ANDERSON, osteotome.
130
 nerve, hook.77
 NEWS, hook.90
 nylon cap, mallet.100

O

O'BRIEN, scissors28
 OBWEGESER, osteotome131
 OBWEGESER, retractor...146, 147, 148
 OBWEGESER, elevator149
 OCHSNER, dressing forceps45
 O'CONNOR, retractor86
 OEHLER, tissue forceps.37
 OLSEN-HEGAR, needle holder93
 osteotome, COTTLE129
 osteotome, MINI-LAMBOTTE132
 osteotome, NEIVERT-ANDERSON.
130
 osteotome, OBWEGESER131
 osteotome, RUBIN.129
 osteotome, SILVER130
 osteotome, TESSIER151

P

PARKES, nasal rasp134
 PARTSCH, mallet100
 PECK-JOSEPH, scissors31
 PEET, nasal rasp134
 pelvimeter, COLLIER.....4
 PENNINGTON, elevator103
 PIERCE, elevator103
 PITANGUY, facelift marker3
 plastic surgery, endoscope153
 plastic surgery,
 endoscope shaft153, 154, 155
 POTTS-SMITH, dressing forceps...36
 POTTS-SMITH, tissue forceps36
 probe, SINUS103
 PROVIDENCE-HOSPITAL, forceps.
61

Q

QUISLING, mallet100

R

RAGNELL, retractor65
 RAMUS, retractor148
 raspatory, FOMON.101
 raspatory, JOSEPH.101
 raspatory, TESSIER.150
 MT-BRAUN INSTRUMENTE, retractor
72
 MT-BRAUN INSTRUMENTE, nasal
 specula112
 MT-BRAUN INSTRUMENTE, knife.125
 REES, elevator128
 retractor, ALM75
 retractor, ANDERSON79
 retractor, AUFRICHT87
 retractor, BARSKY71
 retractor, BIGGS84
 retractor, BREAST79
 retractor, CONVERSE87
 retractor, CONVERSE89
 retractor, CORONAL79
 retractor, COTTLE87, 88, 89
 retractor, COTTLE-NEIVERT88
 retractor, CRILE65
 retractor, DEAVER67
 retractor, DESMARRES73
 retractor, FARABEUF65
 retractor, FERRIERA78
 retractor, FINSEN75
 retractor, FOMON88
 retractor, FREEMAN68, 79, 81
 retractor, FREER88
 retractor, GILLIES89
 retractor, GORNEY81
 retractor, GRAEFE69
 retractor, GUTHRIE69
 retractor, HOLZHEIMER75
 retractor, HUMBY71
 retractor, JANSEN75
 retractor, JOSEPH70
 retractor, KASDAN73
 retractor, KILNER88
 retractor, KLAPP72
 retractor, KLEINERT-KUTZ70
 retractor, KNAPP86
 retractor, LAHEY70
 retractor, LANGE89
 retractor, MALINIAC87
 retractor, MASING-NEIVERT87
 retractor, MEYERDING74
 retractor, MILLER86
 retractor, OBWEGESER...146, 147, 148

retractor, RAMUS148
 retractor, MT-BRAUN INSTRUMENTE 72
 retractor, RIBBON66
 retractor, ROLLET86
 retractor, ROUX65
 retractor, SPINA-NASALIS148
 retractor, STRANDELL-STILLE74
 retractor, TEBBETS78, 83
 retractor, TYRELL69
 retractor, VOLKMANN73
 retractor, WEITLANER76
 retractor, WIENER86
 retractor, YANKOSKIE79
 REYNOLDS, scissors19
 RIBBON, retractor66
 ROCHESTER-OCHSNER, forceps...63
 ROCHESTER-PEAN, forceps63
 ROLLET, retractor.86
 rongeur, BEYER98
 rongeur, BÖHLER98
 rongeur, FRIEDMANN98
 rongeur, FRIEDMANN MINI98
 ROUX, retractor65
 RUBIN, septum forceps.122
 RUBIN, osteotome.129
 ruler, metal.2
 RUSSEL-DAVIS, tongue depressor.
145
 RUSSIAN PATTERN, tissue forceps .
42
 RYDER, needle holder93

S

SANVENERO, scissors18
 scalpel, handles7, 8, 9, 10, 12
 scalpel, blades11
 scalpel blade remover,11
 SCHINK, dermatome5
 SCHMEDEN, nasal cutting forceps.
121
 scissors, BEUSE31
 scissors, BONN20
 scissors, CHADWICK26
 scissors, CONVERSE/WILMER22
 scissors, COTTLE22, 27
 scissors, COTTLE-MASING27
 scissors, FOMON27
 scissors, GOLDMAN-FOX29
 scissors, GORNEY30
 scissors, GORNEY-FREEMAN30
 scissors, GRADLE23
 scissors, GRAEFE22

scissors, GREENBERG-PAR32	STEVENS, scissors24	tongue depressor, RUSSEL-DAVIS145
scissors, HEYMAN27	STILLE, dressing forceps36	tongue depressor, WIEDER141
scissors, IRIS20	STILLE, tissue forceps37	TROELTSCH, ear forceps57
scissors, JOSEPH18	STILLE-BARRAYA, tissue forceps.....45	TYRELL, retractor69
scissors, KAYE31, 32	STRABISMUS, scissors24	
scissors, KELLY19	STRANDELL-STILLE, retractor74	U
scissors, KILNER19	suction tube, BARON107	USA, dressing forceps36
scissors, KNAPP21	suction tube, ADSON107	USA, tissue forceps37
scissors, LA GRANGE26	suction tube, FRAZIER/FERGUS- SON108	
scissors, LEXER15	suction tube, GUILLEN109	V
scissors, LEXER-BABY15	suture forceps, CASTROVIEJO55	VOLKMANN, retractor73
scissors, LITTAUER28	suture forceps, MOD. BONN.54	
scissors, LITTLER22	suture forceps, MOD. TUEBINGEN....54	W
scissors, MAYO13		WAGNER, scissors25
scissors, MAYO-STILLE14	T	WALSHAM, septum
scissors, MC INDOE29	TAKAHASHI, nasal cutting forceps...121	straightening forceps140
scissors, METZENBAUM16, 17	TAYLOR, dressing forceps44	WATSON, dermatome6
scissors, METZENBAUM-FINO17	TAYLOR, tissue forceps44	WAUGH, tissue forceps41
scissors, micro33, 34, 35	TEBBETS, retractor78, 83	WEBSTER, needle holder91
scissors, O'BRIEN28	TESSIER, raspatory150	WEIL-BLAKESLEY, nasal
scissors, PECK-JOSEPH31	TESSIER, osteotome151	cutting forceps120
scissors, REYNOLDS19	TIECK-HALLE, nasal specula.....112	WEITLANER, retractor76
scissors, SANVENERO18	tissue, forceps36, 37	WEST, gouge132
scissors, SPENCER28	tissue forceps, ADSON38, 39	WEST, chisel132
scissors, STEVENS24	tissue forceps, ADSON-BROWN40	WESTMACOTT, nasal forceps117
scissors, STRABISMUS24	tissue forceps,	WILDE (TROELTSCH), ear forceps ...57
scissors, WAGNER25	BEASELEY BABCOCK39	WIEDER, tongue depressor141
scissors, WILMER/CONVERSE22	tissue forceps, BONNEY45	WIENER, retractor86
SEMKEN, dressing forceps43	tissue forceps, BROWN41	WIENER, nasal rasp134
SEMKEN, tissue forceps43	tissue forceps, COLLIN-DUVAL.....42	WILLIGER, elevator101
septum forceps, BRUENINGS119	tissue forceps, CUSHING41	WILMER/CONVERSE, scissors22
septum forceps, GRAIG119	tissue forceps, DURANTE45	wire brush, nasal rasp138
septum forceps, LUC119	tissue forceps, DUVAL42	wire twisting forceps, BERRY97
septum forceps, MIDDLETON- JANSEN123	tissue forceps, FERRIS-SMITH42	wire twisting forceps, MAYO- HABERISSER97
septum forceps, RUBIN122	tissue forceps, GERALD44	
septum straightening forceps, ASCH.140	tissue forceps, GILLIES43	Y
septum straightening forceps, WAL- SHAM140	tissue forceps, GRAEFE41	YANKOSKIE, retractor79
SILVER, dermatome6	tissue forceps, LERCHE41	
SILVER, osteotome130	tissue forceps, McINDOE42	
SILVERSTEIN, dissector83	tissue forceps, OEHLER37	
SINGLEY, dressing forceps45	tissue forceps, POTTS-SMITH36	
SINUS, probe103	tissue forceps,	
skin plate for dermatomes5	RUSSIAN PATTERN42	
spare blades for dermatomes5, 6	tissue forceps, SEMKEN43	
spatula, breast80	tissue forceps, STILLE37	
Spatula electrode, monopolar158	tissue forceps, STILLE-BARRAYA45	
SPENCER, scissors28	tissue forceps, TAYLOR44	
SPINA-NASALIS, retractor148	tissue forceps, USA37	
splinter, forceps46	tissue forceps, WAUGH41	
	tongue depressor, ANDREW141	
	tongue depressor, JENNINGS141	

A

abre-boca DAVIS-BOYLE142
 abre-boca DAVIS-MEYER144
 abre-boca DINGMANN143
 abre-boca JENNINGS141
 abre-boca KILNER-DOUGHTY143
 abre-boca McIVOR144
 ADSON gancho para duramadre...85
 ADSON
 micro pinza de diseccion38, 39
 ADSON pinza de diseccion38, 39
 ADSON pinza hemostatica64
 ADSON tubo de aspiracion.....107
 ADSON-BROWN
 pinza de diseccion40
 ADSON-DeBAKEY
 pinza de diseccion38
 AGRIS-DINGMAN
 separador mamario82
 ALM separador75
 ANDERSON separador79
 ANDREW baja-lengua141
 ASCH pinza para enderezar
 el tabique nasal140
 AUFRIEHT escofina nasal135
 AUFRIEHT separador nasal87

B

BABY OLSEN-HEGAR porta aguja...93
 baja-lengua ANDREW141
 baja-lengua McIVOR144
 baja-lengua RUSSEL-DAVIS.....145
 baja-lengua WIEDER141
 BALLENGER cuchillo para el tabique
 nasal126
 BALLENGER elevador para tabique.
104
 BARON tubo de aspiracion.....107
 BARRAQUER micro porta aguja...95
 BARRAQUER pinza depilatoria...55
 BARSKY separador71
 BAUMGARTNER porta aguja.....92
 BEASELEY BABCOCK pinza de dis-
 eccion39
 BERKE pinza muscular55
 BERRY pinza para torcer hilos97
 BEUSE Face Lift tijera31
 BEYER pinza gubia98
 BIGGS separador84
 BISHOP-HARMAN pinza para iris.....53
 BLAIR instrumento para labios y
 fisura palatina106

BÖHLER pinza gubia98, 99
 BOIES elevador102
 BONN Mod. pinza para sutura.....54
 BONN tijera fina20
 BONNEY pinza de diseccion45
 BREAST separador79
 BROWN pinza de diseccion41
 BRUENINGS pinza para el
 tabique nasal119

C

CAPLAN tijera para cartilago.....122
 CASTROVIEJO compas4
 CASTROVIEJO micro porta aguja...96
 CASTROVIEJO pinza para sutura.....55
 cepillo de alambre138
 CHADWICK tijera fina26
 cincel COTTLE129
 cincel SILVER130
 COLLER-CRILE pinza hemostatica...61
 COLLIER pelvimetro4
 COLLIN-DUVAL pinza de diseccion...42
 compas CASTROVIEJO4
 CONVERSE cuchillo nasal125
 CONVERSE separador89
 CONVERSE separador nasal87
 CONVERSE/WILMER tijera fina.....22
 CORONAL separador79
 COTTLE cincel129
 COTTLE cuchillo nasal125
 COTTLE elevador para tabique...104
 COTTLE escofina nasal135
 COTTLE especulo nasal115, 116
 COTTLE JOSEPH elevador103
 COTTLE legra104
 COTTLE macha cadera133
 COTTLE martillo100
 COTTLE osteotomo129
 COTTLE pinza para columela57
 COTTLE pinza para fijacion57
 COTTLE separador89
 COTTLE separador nasal.....87, 88
 COTTLE tijera fina22
 COTTLE tijera nasal27
 COTTLE-KAZANJIAN pinza gubia...99
 COTTLE-MASING tijera nasal27
 COTTLE-NEIVERT separador nasal..88
 CRILE gancho para nervios.....85
 CRILE pinza hemostatica62
 CRILE separador65
 CRILE-RANKIN pinza hemostatica...62
 CRILE-WOOD porta aguja92

CRIONIN instrumento
 para labios y fisura palatina106
 cuchillo nasal CONVERSE125
 cuchillo nasal COTTLE125
 cuchillo nasal FREER124
 cuchillo nasal JOSEPH.....124, 125
 cuchillo nasal MT-BRAUN INSTRUMENTE .125
 cuchillo para capsula FOERSTER...127
 cuchillo para el tabique nasal BALLENGER .
126
 CUSHING gancho para nervios.....85
 CUSHING pinza de diseccion41
 CUSHING-TAYLOR pinza de disec-cion .
44

D

D' ASSUMPACO instrumento
 para marcar3
 DAVIS-BOYLE abre-boca142
 DAVIS-MEYER abre-boca144
 DEAYER separador67
 DeBAKEY pinza atraumatica51
 DeBAKEY porta aguja92
 DERF porta aguja91
 dermatomo HUMBY6
 dermatomo SCHINK5
 dermatomo SILVER6
 dermatomo WATSON6
 DESMARRS pinza para chalazion...55
 DES-
 MARRS separador73
 DINGMAN elevador150
 DINGMAN escofina nasal138
 DINGMAN legra150
 DINGMANN abre-boca143
 disector GORNEY102
 disector LANGENBECK77
 disector LANGENBECK-COTTLE77
 disector MINI-LANGENBECK77
 DURANTE pinza de diseccion45
 DUVAL pinza de diseccion42

E	FERRIERA separador.....78	GRAIG pinza para el tabique nasal119
elevador BOIES102	FERRIS-SMITH pinza de diseccion42	GREEN pinza para fijacion.....56
elevador COTTLE JOSEPH103	FINSEN separador75	GREENBERG-PAR tijera para blefaroplastia32
elevador DINGMAN150	FOERSTER cuchillo para capsula.....127	gubia FREER132
elevador FREER102, 128	FOMON escofina nasal136, 137	gubia HAJEK132
elevador HOWARTH103	FOMON legra101	gubia KILLIAN130
elevador JOSEPH102, 103	FOMON separador nasal88	gubia KILLIAN-CLAUS132
elevador KILLIAN103, 104	FOMON tijera nasal27	gubia WEST132
elevador MASING102	FRAZIER separador70	GUILLEN tubo de aspiracion109
elevador McKENTY102, 103	FRAZIER/FERGUSSON tubo de aspiracion108	GUTHRIE separador69
elevador para el tabique REES128	FREEMAN Face separador81	
elevador para tabique BALLENGER104	FREEMAN marcador para aréola.....4	H
elevador para tabique COTTLE.....104	FREEMAN separador68	HAJEK gubia132
elevador para tabique HAJEK-BALLENGER104	FREEMAN separador79	HAJEK-BALLENGER elevador para tabique104
elevador PENNINGTON103	FREER cuchillo nasal124	HALSEY porta aguja91
elevador PIERCE103	FREER elevador102, 128	HALSTEAD-MOSQUITO micro pinza hemostatica60
elevador SINUS103	FREER gubia132	HALSTEAD-MOSQUITO pinza hemostatica60
escofina nasal AUFRICHT135	FREER separador nasal88	HARTMANN espejito nasal.....111
escofina nasal COTTLE135	FRIEDMANN MICRO pinza gubia.....98	HARTMANN pinza hemostatica59
escofina nasal DINGMAN138	FRIEDMANN MINI pinza gubia98	HARTMANN pinza para polipos ...117
escofina nasal FOMON136, 137	FRIEDMANN pinza gubia98	HARTMANN-HALLE espejito nasal110
escofina nasal GLABELLA134		HEYMAN tijera nasal27
escofina nasal JOSEPH134, 135	G	HEYMANN-KNIGHT pinza para polipos.....118
escofina nasal LEWIS135	gancho para duramadre ADSON85	hoja de repuesto para dermatomo5, 6
escofina nasal MALTZ134, 135	gancho para nervios77, 85	hojas de bisturie11
escofina nasal PARKES134	gancho para nervios CRILE85	HOLZHEIMER separador75
escofina nasal PEET134	gancho para nervios CUSHING85	HOWARTH elevador103
escofina nasal WIENER134	gancho para traqueotomia JACKSON90	HUMBY dermatomo6
espatula80	gancho para traqueotomia NEWS90	HUMBY separador71
espatula abdominal e intestinal RIBBON66	GERALD pinza de diseccion43, 44	
espejito nasal COTTLE115, 116	GERZOG martillo100	
espejito nasal HARTMANN111	GILLIES pinza de diseccion43	
espejito nasal HARTMANN-HALLE110	GILLIES porta aguja94	
espejito nasal KILLIAN.....113, 114	GILLIES separador89	
espejito nasal Mod. WIEN112	GLABELLA escofina nasal134	
espejito nasal MT-BRAUN INSTRUMENTE112	GOLDMAN-FOX tijera para encias.....29	
espejito nasal TIECK-HALLE112	GONIMETRO MOELTGEN2	
	goniometro para dedos2	
	GORNEY disector102	
F	GORNEY Face Lift tijera30	
Face Lift tijera BEUSE31	GORNEY separador81	
Face Lift tijera GORNEY30	GORNEY-FREEMAN Face Lift tijera30	
Face Lift tijera GORNEY-FREEMAN30	GRADLE tijera fina23	
Face Lift tijera KAYE31	GRAEFE pinza de diseccion41	
Face Lift tijera PECK-JOSEPH31	GRAEFE pinza para iris52	
FARABEUF separador65	GRAEFE separador69	
FERGUSSON/FRAZIER tubo de aspiracion108	GRAEFE tijera fina22	

P		
PARKES escofina nasal	134	pinza de diseccion STILLE-
PARTSCH martillo	100	BARRAYA
PECK-JOSEPH Face Lift tijera	31	pinza de diseccion TAYLOR
PEET escofina nasal	134	pinza de diseccion TAYLOR-
pelvimetro COLLIER	4	CUSHING
PENNINGTON elevador	103	pinza de diseccion USA
PIERCE elevador	103	pinza de diseccion WAUGH
pinza atraumatica DeBAKEY	51	pinza depilatoria BARRAQUER
pinza auricular JANSEN-GRUEN-		pinza gubia BEYER
WALD	57	pinza gubia BÖHLER
pinza auricular LUCAE	57	pinza gubia COTTLE-KAZANJIAN
pinza auricular TROELTSCH	57	pinza gubia FRIEDMANN
pinza auricular WILDE		pinza gubia FRIEDMANN MINI
(TROELTSCH)	57	pinza gubia MC INDOE
pinza cortante nasal MYLES	121	pinza gubia MICRO FRIEDMANN
pinza cortante nasal		pinza hemostatica ADSON
SCHMEDEN	121	pinza hemostatica COLLER-CRILE
pinza cortante nasal TAKAHASHI.		pinza hemostatica CRILE
.	121	pinza hemostatica CRILE-RANKIN
pinza cortante nasal WEIL-		pinza hemostatica HALSTEAD-
BLAKESLEY	120	MOSQUITO
pinza de diseccion ADSON	38, 39	pinza hemostatica HALSTEAD-
pinza de diseccion		MOSQUITO micro
ADSON micro	38, 39	pinza hemostatica HARTMANN
pinza de diseccion ADSON-BROWN .		pinza hemostatica KELLY
.	40	pinza hemostatica KELLY-RANKIN
pinza de diseccion ADSON-		pinza hemostatica LERICHE
DeBAKEY	38	pinza hemostatica PROVIDENCE-
pinza de diseccion		HOSPITAL
BEASELEY BABCOCK	39	pinza hemostatica ROCHESTER-
pinza de diseccion BONNEY	45	OCHSNER
pinza de diseccion BROWN	41	pinza hemostatica ROCHESTER-
pinza de diseccion COLLIN-DUVAL	42	PEAN
pinza de diseccion CUSHING	41	pinza muscular BERKE
pinza de diseccion CUSHING-		pinza para chalazion DESMARRES .
TAYLOR	44
pinza de diseccion DURANTE	45	pinza para columela COTTLE
pinza de diseccion DUVAL	42	pinza para el tabique nasal
pinza de diseccion FERRIS-SMITH	42	BRUENINGS
pinza de diseccion GERALD	43, 44	pinza para el tabique nasal
pinza de diseccion GILLIES	43	GRAIG
pinza de diseccion GRAEFE	41	pinza para el tabique nasal
pinza de diseccion LERCHE	41	KNIGHT
pinza de diseccion McINDOE	42	pinza para el tabique nasal LUC
pinza de diseccion Mod. RUSO	42	pinza para el tabique nasal MIDDLE-
pinza de diseccion OCHSNER	45	TON-JANSEN
pinza de diseccion OEHLER	37	pinza para el tabique nasal RUBIN
pinza de diseccion POTTS-SMITH	36	pinza para enderezar el tabique nasal
pinza de diseccion SEMKEN	43	ASCH
pinza de diseccion SINGLEY	45	pinza para enderezar el tabique nasal
pinza de diseccion STILLE	36, 37	WALSHAM
		pinza para fijacion COTTLE
		pinza para fijacion GREEN
		pinza para iris BISHOP-HARMAN
		pinza para iris GRAEFE
		pinza para polipos HARTMANN
		pinza para polipos HEYMANN-
		KNIGHT
		pinza para sutura CASTROVIEJO
		pinza para sutura Mod. BONN
		pinza para sutura
		Mod. TUEBINGEN
		pinza para taponamiento LUBET-
		BARBON
		pinza para taponamiento WESTMA-
		COTT
		pinza para torcer hilos BERRY
		pinza para torcer hilos MAYO-
		HABERISSER
		pinzas atraumaticas con TC
		pinzas de diseccion sin y con
		dientes
		pinzas para espinas
		PITANGUY marcador para facelift
		placa para extender la piel
		placa para parado JAEGER
		porta aguja BABY OLSEN-HEGAR
		porta aguja BAUMGARTNER
		porta aguja CRILE-WOOD
		porta aguja DeBAKEY
		porta aguja DERF
		porta aguja GILLIES
		porta aguja HALSEY
		porta aguja MAYO-HEGAR
		porta aguja MICROVASCULAR
		porta aguja OLSEN-HEGAR
		porta aguja RYDER
		porta aguja WEBSTER
		POTTS-SMITH pinza de diseccion
		PROVIDENCE-HOSPITAL
		pinza hemostatica
		Q
		QUISLING martillo

tijera fina LITTLER	22
tijera fina para oftalmología	23
tijera fina STEVENS	24
tijera fina STRABISMUS	24
tijera fina WAGNER	25
tijera fina WILMER/CONVERSE	22
tijera nasal COTTLE	27
tijera nasal COTTLE-MASING	27
tijera nasal FOMON	27
tijera nasal HEYMAN	27
tijera para blefaroplastia GREEN- BERG-PAR	32
tijera para blefaroplastia KAYE	32
tijera para cartilago CAPLAN	122
tijera para cartilago MC INDOE	29
tijera para encias GOLDMAN-FOX	29
tijera para hilos LITTAUER	28
tijera para hilos O'BRIEN	28
tijera para hilos SPENCER	28
TROELTSCH pinza auricular	57
tubo de aspiracion ADSON	107
tubo de aspiracion BARON	107
tubo de aspiracion FRAZIER/ FERGUSSON	108
tubo de aspiracion GUILLEN	109
TUEBINGEN Mod. pinza para sutura	54
TYRELL separador	69

U

USA pinza de diseccion	36, 37
----------------------------------	--------

V

VOLKMANN separador	73
------------------------------	----

W

WAGNER tijera fina	25
WALSHAM pinza para enderezar el tabique nasal	140
WATSON dermatomo	6
WAUGH pinza de diseccion	41
WEBSTER porta aguja	91
WEIL-BLAKESLEY pinza cortante nasal	120
WEITLANER separador	76
WEST gubia	132
WEST osteotomo	132
WESTMACOTT pinza para taponamiento	117
WIEDER baja-lengua	141
WIEN Mod. espejulo nasal	112
WIENER escofina nasal	134
WIENER separador	86
WILDE (TROELTSCH) pinza auricu- lar	57
WILLIGER legra	101
WILMER/CONVERSE tijera fina	22

Y

YANKOSKIE separador	79
-------------------------------	----

A	BONNEY pinze chirurgiche	45	COTTLE scalpello per plastica nasale	129
Abbassalingua Andrew	Breast divaricatore	79	Cottle specoli nasali	115
abbassalingua Davis-Boyle	BROWN Pinze chirurgiche	41	Cottle specoli nasali	116
abbassalingua Dingmann	BRUENINGS pinza per il setto nasale	119	Cottle Tritacartilagine	133
abbassalingua Kilner-Doughty			Cottle-Joseph elevatore per setto	103
abbassalingua Russel-Davis	C		COTTLE-MASING forbici nasali	27
abbassalingua Wieder	Camicia per chirurgia plastica	153	Cottle-Neivert retrattore nasale	88
Adson cannula di aspirazione	Camicia per chirurgia plastica	154	CRILE divaricatore doppio	65
ADSON pinza emostatica	Camicia per chirurgia plastica	155	CRILE pinze emostatiche	62
Adson uncini per dura-madre	Cannula di aspirazione	107	CRILE RANKIN pinze emostatiche	62
AGRIS-DINGMAN separatori mammari	cannula di aspirazione Baron	107	Crile uncini per nervi	85
ALM divaricatori	Cannula di aspirazione Guilen	109	CRILE WOOD portaghi	92
Anderson uncini per pelle	Cannule di aspirazione Frazier/ Fergusson	108	CUSHING pinza anatomica	41
ANDREW abbassalingua	CAPLAN cesoia per setto nasale	122	CUSHING pinza chirurgica 1x2	41
Apribocca completo Davis-Boyle	Castroviejo compasso	4	Cushing uncini per nervi	85
apribocca Dingmann	Castroviejo micro portaghi	96	Cushing-Taylor pinza a baionetta	44
apribocca Jennings	Castroviejo pinze per sutura	55		
apribocca KILNER DOUGHTY	Cesoia per setto nasale Caplan	122	D	
ASCH pinza per raddrizzare il setto nasale	Chadwick forbici gingivali	26	D'ASSUMPACO strumento per marcare	3
AUFRICHT raspa nasale	Coller-Crile pinze emostatiche	61	DAVIS BOYLE abbassalingua	142
Aufricht retrattori nasali	Collier compasso	4	DAVIS BOYLE apribocca completo	142
	COLLIN DUVAL pinza fenestrata	42	Davis-Boyle Telaio solo	142
B	coltello falcato MT-BRAUN INSTRUMENTE	125	Davis-Meyer Telaio solo	144
Baby OLSEN HEGAR portaghi	Coltello per capsula Foerster	127	DE BAKEY portaghi	92
BABY-WEBSTER portaghi	Coltello per il setto nasale Freer	124	DEAVER divaricatori addominali	67
BALLENGER coltello per setto	Coltello per mucosa Freer	124	DEBAKEY micro pinza atraumatica	49
Ballenger elevatore per setto	coltello per setto Ballenger	126	DeBaKey pinze atraumatiche	51
BARON Cannula di aspirazione	Compasso Castroviejo	4	DeBaKey pinze atraumatiche TC	50
BARRAQUER micro portaghi	Compasso Collier	4	DERF portaghi	91
Barraquer pinza depilatoria	CONVERSE bisturi per rinoplastica	125	Dermatomo Humby	6
BARSKY uncinetto per pelle	Converse divaricatore	89	Dermatomo Schink	5
BAUMGARTNER portaghi	Converse retrattori nasali	87	Dermatomo Silver	6
Berke pinze muscolari	CONVERSE/WILMER forbici delicate	22	Dermatomo Watson	6
Berry Pinza torcifili	CORONAL divaricatore	79	DESMARRES divaricatori	73
BEUSE face lift forbici	COTTLE bisturi per setto nasale	125	Desmarres pinze per calazio	55
BEYER pinza sgorbia	Cottle divaricatori	89	Dingman divaricatore	150
Biggs divaricatore con luce fredda	Cottle elevatore per setto	103	DINGMAN raspa nasale	138
Bishop-Harmann pinze per iride	Cottle elevatore per setto	104	DINGMANN abbassalingua	143
Bisturi per cartilagine Joseph	Cottle forbici delicate	22	DINGMANN apribocca	143
bisturi per rinoplastica Converse	COTTLE forbici nasali	27	DINGMANN periostotomo doppio	150
bisturi per rinoplastica Cottle	COTTLE KAZANJIAN cesoia per ossa	99	Dischi di ricambio per martello	100
Bisturi per rinoplastica Joseph	COTTLE martello metallico	100	Dissettor Gorney	102
BLAIR elevatore per fessure del palato	COTTLE osteotomo	129	dissettori Williger	101
BOEHLER cesoie per ossa	Cottle pinza per columella	57	divaricat dopp.coppia Farabeuf	65
BOEHLER pinza sgorbia	Cottle retrattore nasale	87	Divaricatore	150
BOIES sgorbia periostotomo	Cottle retrattore nasale	88	Divaricatore Breast	79
BONN forbice delicata			Divaricatore con luce fredda Biggs	84
BONNEY pinza anatomica			Divaricatore Converse	89
BONNEY pinze chirurgiche			Divaricatore Coronal	79

Divaricatore Dingman150	Elevatore per setto Hajek-Ballenger104	Forbici nasali Fomon27
Divaricatore doppio Crile65	Elevatore per setto Howarth103	Forbici nasali Heymann27
Divaricatore doppio Ragnel65	Elevatore per setto Joseph102	Forbici per dissezione15
Divaricatore doppio Roux65	Elevatore per setto Killian103	Forbici per dissezione19
Divaricatore Freemann81	Elevatore per setto Killian104	Forbici per dissezione Joseph18
Divaricatore Gorney81	Elevatore per setto McKenty102	Forbici per dissezione Kilner19
Divaricatore Kasdan73	Elevatore per setto McKenty103	Forbici per dissezione Lexer-Baby15
Divaricatore Knapp86	elevatore per setto nasale Rees...128	Forbici per dissezione MAYO13
Divaricatore Lange89	Elevatore per setto Pennington103	Forbici per dissezione MAYO-Stille14
Divaricatore Martinez-Kilner89	Elevatore per setto Pierce103	Forbici per dissezione Metzenbaum...16
Divaricatore Miller86	Elevatore per setto Sinus103	Forbici per dissezione Metzenbaum...17
divaricatore Obwegeser146	Endo dissettore Langenbeck77	Forbici per dissezione SANVENERO18
divaricatore Obwegeser148	Endo dissettore Langenbeck-Cottle...77	Forbici per strabismo24
Divaricatore O'Connor86	Endo dissettore Mini-Langenbeck77	Forbici taglia fili Littauer28
Divaricatore Ramus148	F	Forbici taglia fili O'Brien28
Divaricatore Rollet86	Face lift forbici Beuse31	Forbici taglia fili Spencer28
Divaricatore Spina-Nasalis148	Face lift forbici Gorney.....30	FRAZIER uncinetto acuto70
Divaricatore Tessier150	Face lift forbici Gorney-Freemann.....30	FRAZIER uncinetto smusso70
Divaricatori72	Face lift forbici Kaye31	Frazier/Fergusson cannula di aspirazione108
Divaricatori addominali Deaver67	Face lift forbici Peck-Joseph.....31	FREEMAN divaricatore81
Divaricatori Alm75	FARABEUF divaricat.dopp.coppia.....65	Freeman divaricatori68
Divaricatori Cottle89	Ferriera divaricatori78	FREEMAN divaricatori79
Divaricatori Desmarres73	FERRIS SMITH pinze chirurgiche42	FREEMAN, strumento per marcare4
Divaricatori Ferriera78	FINSEN divaricatori75	FREER coltello per il setto nasale124
Divaricatori Ferriera78	FOERSTER coltello per capsula127	FREER coltello per mucosa124
Divaricatori Finsen75	FOMON forbici nasali27	FREER elevatore per setto.....102
Divaricatori Freeman68	FOMON Periostotomo101	FREER osteotomo per setto nasale128
Divaricatori Freeman79	FOMON raspa nasale doppia136	Freer retrattore nasale88
Divaricatori Gillies89	FOMON raspa nasale doppia137	FREER sgorbia nasale132
Divaricatori Holzheimer75	Fomon retrattori nasali88	FRIEDMAN MICRO pinza sgorbia98
Divaricatori Jansen75	forbice delicata Bonn20	FRIEDMAN mini pinza sgorbia.....98
Divaricatori Klapp72	Forbici blefaroplastica.....32	
Divaricatori Lahey70	forbici bleforoplastica Greenberg-Par.32	
Divaricatori Meyerding74	Forbici delicate24	G
divaricatori Strandel-Stille74	Forbici delicate Converse/Wilmer...22	Ganci per tracheotomia Jackson90
Divaricatori Volkmann73	Forbici delicate Cottle22	Gancio per tracheotomia News90
Divaricatori Weitlaner76	Forbici delicate Gradle23	GERALD pinza chirurgica 1x243
Divaricatori Wiener86	Forbici delicate Graefe22	GERALD pinze anatomiche43
Divaricatori Yancoskie79	forbici delicate IRIS20	GERALD pinze chirurgiche44
DURANTE pinze anatomiche45	Forbici delicate Knapp21	GERZOG Martello metallico100
DUVAL pinza fenestrata42	Forbici delicate Littler22	Gillies Divaricatori89
E	Forbici delicate Wagner25	GILLIES pinze 1x2 denti43
Elettrodi monopolari158	Forbici endoscopici156	GILLIES portaghi tagliente94
Elevatore Langenbeck101	Forbici gingivali Chadwick26	Glabella raspa nasale134
elevatore per periostio Masing102	Forbici gingivali Goldmann-Fox29	GOLDMANN-FOX forbici gingivali29
Elevatore per setto104	Forbici gingivali La Grange26	Goniometro Moeltgen2
Elevatore per setto Cottle103	Forbici gingivali Mc Indoe29	Goniometro per le dita2
Elevatore per setto Cottle104	Forbici nasali Cottle27	GORNEY dissettore102
Elevatore per setto Cottle-Joseph 103	Forbici nasali Cottle-Masing27	Gorney divaricatore81
Elevatore per setto Freer.....102		

Gorney face lift forbici.....30	JOSEPH sega nasale angolata139	LUC pinza tagliente per il setto nasale119
Gorney-Freemann face lift forbici30	JOSEPH uncino mucosa70	Lucae pinze auricolari.....57
Gradle forbici delicate23	Jost tritacartilagine133	
GRAEFE forbici delicate22		
GRAEFE pinza morsi dentellati.....41	K	M
Graefe pinze per iride.....52	Kasdan divaricatore73	MacCollum-Dingmann
GRAEFE uncinetto acuto69	KAYE face lift forbici31	separatori mammari83
GRAEFE uncinetto smusso69	Kaye forbici blefaroplastica.....32	Maliniac retrattore nasale87
Graig pinza per il setto nasale119	Kelly forbici per dissezione19	MALTZ (COTTLE) raspa nasale135
Green pinze fissatrici56	KELLY pinze emostatiche.....51	Maltz raspa nasale134
GREENBERG-PAR forbici bleforaplastica32	KELLY RANKIN pinze emostatiche...61	Manici per lame bisturi7
Guilen cannula di aspirazione109	KILLIAN elevatore per setto103	Manici per lame bisturi9
GUTHRIE uncinetto doppio acuto69	KILLIAN elevatore per setto104	Manici per lame bisturi.....10
GUTHRIE uncinetto doppio smusso...69	Killian sgorbia130	Manici per lame bisturi.....12
	Killian specoli nasali113	Martelli100
H	Killian specoli nasali114	Martello intranasale Quisling100
HAJEK sgorbia132	KILNER DOUGHTY	Martello Mead100
Hajek-Ballenger elevatore per setto104	abbassalingua143	Martello metallico Cottle100
HALSEY portaghi91	KILNER DOUGHTY apribocca143	Martello metallico Gerzog100
HALSTED-Mosquito micro pinze.....60	KILNER forbici per dissezione19	Martello metallico Partsch100
HALSTED-Mosquito pinze.....60	Kilner retrattore nasale88	Martinez-Kilner divaricatore89
HARTMANN pinza per polipi nasali117	Klapp divaricatori72	MASING elevatore per peristio...102
Hartmann pinze emostatiche.....59	KLEINERT-KUTZ uncinetto acuto per pelle70	Masing-Neivert retrattore nasale87
Hartmann specoli nasali.....111	Knapp divaricatore86	MAYO forbici per dissezione.....13
Hartmann-Halle specoli nasali110	KNAPP forbici delicate21	Mayo-HaberlSSER pinze torcifili ...97
HEYMANN forbici nasali27	KNIGHT pinza per il setto118	MAYO-Hegar portaghi92
HEYMANN KNIGHT pinza nasale118		MAYO-Stille forbici per dissezione.....14
HOLZHEIMER divaricatori.....75	L	MC INDOE cesoia per ossa99
HOWARTH elevatore per setto103	La Grange forbici gengivali26	MC Indoe forbici gengivali29
Humby dermatomo6	LAHEY divaricatori70	McINDOE pinza 1x2 denti42
HUMBY uncinetto doppio per pelle.....71	Lama di ricambio per dermatomo.....5	MCINDOE pinza anatomica42
	Lama di ricambio, non sterile.....6	McIVOR abbassalingua144
I	Lame per bisturi10	McIVOR apribocca completo.....144
Iris forbici delicate20	Lame per bisturi11	McKENTY elevatore per setto102
	Lange divaricatore89	McKENTY elevatore per setto103
J	LANGENBECK elevatore101	McKISSOCK, strumento per marcare4
Jackson ganci per tracheotomia90	LANGENBECK Endo disettore.....77	MEAD martello100
JANSEN divaricatori75	LANGENBECK-Cottle Endo disseutori77	METZENBAUM forbici per dissezione.....16
Jansen-Gruenwald pinza auricolare57	LERCHE pinza 5x6 denti41	METZENBAUM forbici per dissezione17
JENNINGS apribocca141	LERICHE pinze emostatiche63	MEYERDING divaricatori74
JOSEPH (LEWIS) raspa nasale ...135	LEXER baby forbici per dissezione ...15	Micro forbici34
JOSEPH bisturi per cartilagine124	LEXER forbici per dissezione15	Micro forbici35
JOSEPH bisturi per rinoplastica ...124	lima per ossa Joseph134	Micro forbici33
Joseph elevatore per setto102	LITTAUER forbici taglia fili28	Micro pinze ad anello48
JOSEPH forbici per dissezione18	LITTLER forbici delicate22	Micro pinze Halsted-Mosquito60
JOSEPH lima per ossa134	LOCKWOOD strumento per marcare3	Micro pinze per legature47
JOSEPH Periototomo101	LUBET-BARBON pinza per medicature117	micro portaghi Barraquer95
JOSEPH sega nasale138		micro portaghi Castroviejo96

MICROVASCULAR portagli	93	pinza anatomica Cushing	41	Pinze Adson-Brown, chirurgiche	40
MIDDLETON JANSEN pinza per il setto nasale	123	Pinza anatomica Potts-Smith	36	Pinze anatomiche Durante	45
Miller divaricatore	86	Pinza auricolare Jansen-Gruenwald	57	pinze anatomiche Gerald	43
Mini-Lambotte osteotomo	132	Pinza auricolare Wilde (Troeltsch)	57	pinze anatomiche Semken	43
MINI-LANGENBECK Endo disset- tore	77	pinza chirurgica 1x2 Gerald	43	Pinze anatomiche Stille	36
MOELTGEN goniometro	2	Pinza chirurgica Cushing	41	Pinze atraumatiche DeBakey	50
MYLES pinza nasale tagliante	121	Pinza chirurgica Stille	37	Pinze atraumatiche DeBakey	51
N		pinza con cucchiaino, modello russo	42	Pinze auricolari Lucae	57
Neivert-Anderson Osteotomo	130	Pinza depilatoria Barraquer	55	Pinze auricolari Troeltsch	57
News gancio per tracheotomia	90	Pinza emostatica Adson	64	Pinze chirurgiche 2x3 denti	37
O		Pinza fenestrata Collin-Duval	42	Pinze chirurgiche 3x4 denti	37
O'BRIEN forbici taglia fili	28	Pinza fenestrata Duval	42	Pinze chirurgiche 4x5 denti	37
OBWEGESER divaricatore	146	Pinza morsi dentellati Graefe	41	Pinze chirurgiche Brown	41
OBWEGESER divaricatore	147	Pinza nasale Heymann-Knight	118	Pinze chirurgiche Ferris-Smith	42
OBWEGESER divaricatore	148	pinza nasale tagliante Myles	121	Pinze chirurgiche Gerald	44
OBWEGESER Osteotomo	131	pinza nasale tagliante Schmeden	121	Pinze chirurgiche Stille-Barraya	45
OBWEGESER periototomo	149	pinza nasale tagliante Takahashi	121	Pinze chirurgiche Waugh	41
OCHSNER pinza per dissezione	45	Pinza p. diss. 1x2 denti	37	Pinze da presa per endoscopia	157
O'Connor divaricatore	86	pinza p. dissezione micro	43	Pinze emostatiche Coller-Crile	61
OLSEN HEGAR portagli	93	Pinza per appiattamento setto nasale Rubin	122	pinze emostatiche Crile	62
osteotomo Cottle	129	Pinza per columella Cottle	57	Pinze emostatiche Crile-Rankin	62
Osteotomo Mini-Lambotte	132	Pinza per dissezione Ochsner	45	Pinze emostatiche Hartmann	59
Osteotomo nasale Silver	130	Pinza per il setto Knight	118	Pinze emostatiche Kelly	61
Osteotomo nasale West	132	pinza per il setto nasale Brünings	119	Pinze emostatiche Kelly-Rankin	61
Osteotomo Neivert-Anderson	130	pinza per il setto nasale Graig	119	Pinze emostatiche Leriche	63
Osteotomo Obwegeser	131	pinza per il setto nasale Middleton Jansen	123	Pinze emostatiche Providence-Hospita- l	61
Osteotomo per setto nasale Freer	128	Pinza per medicature Lubet-Baron	117	Pinze emostatiche Rochester- Ochsner	63
osteotomo Rubin	129	Pinza per medicature Westmacott	117	Pinze emostatiche Rochester-Pean	63
Osteotomo Tessier	151	Pinza per polipi nasali HARTMANN	117	Pinze fissatrici Green	56
Ottica per endoplastica	152	pinza per raddrizzare il setto nasale Asch	140	Pinze Halsted-Mosquito	60
P		pinza per raddrizzare il setto nasale Walsham	140	Pinze muscolari Berke	55
Parkes raspa nasale	134	pinza sgorbia Beyer	98	Pinze per calazio Desmarres	55
PARTSCH martello metallico	100	Pinza sgorbia BOEHLER	98	Pinze per dissezione chirurgiche	37
PECK-JOSEPH face lift forbici	31	pinza sgorbia Friedmann	98	pinze per dissezione, chirurgiche/ anatomiche	36
Peeet raspa nasale	134	pinza sgorbia mini Friedman	98	Pinze per iride Bishop-Harmann	53
PENNINGTON Elevatore per setto	103	pinza tagliante nasale Weil-Blakesley	120	Pinze per iride Graefe	52
Periototomo doppio Dingman	150	pinza tagliante per il setto nasale Luc	119	Pinze per schegge	46
Periototomo Fomon	101	Pinza torcifili Berry	97	Pinze per sutura Castroviejo	55
Periototomo Joseph	101	Pinza USA 1x2 denti	37	Pinze per sutura mod. Bonn	54
Periototomo OBWEGESER	149	Pinza USA p. dissezione	36	Pinze per sutura mod. Tuebingen	54
PIERCE Elevatore per setto	103	Pinze 1x2 denti Gillies	43	Pinze per tessuti Singley	45
Pinza 1 x 2 denti Potts-Smith	36	pinze 1x2 denti Semken	43	Pinze torcifili Mayo-Haberisser	97
Pinza 1x2 denti McIndoe	42	Pinze Adson, chirurgiche	39	Pitanguy strumento per marcare	3
Pinza 5x6 denti Lerche	41	Pinze Adson, chirurgiche/anatomiche	38	Placca per palpebre	58
pinza a baionetta Taylor	44			Placca per stendipelle	5
pinza anatomica McIndoe	42			portagli Baby Olsen-Hegar	93
Pinza anatomica Bonney	45			Portagli Baby-Webster	91
				portagli Baumgartner	92
				Portagli Crile-Wood	92

portaghi DeBaKey	92	RUBIN osteotomo	129	STILLE-BARRAYA pinze chirurgiche	45
Portaghi Derf	91	RUBIN pinza per appiattamento setto nasale	122	STRANDELL-STILLE divaricatori	74
Portaghi Halsey	91	Russel-Davis abbassalingua	145	Strumenti per labbra e palato	105
portaghi Mayo-Hegar	92	RYDER portaghi	93	Strumenti per labbra e palato Blair	106
Portaghi microvascular	93	S		strumento per marcare	
portaghi Olsen-Hegar	93	SANVENERO forbici per dissezione	18	D'Assumpaco	3
portaghi Ryder	93	scalpello per plastica nasale		strumento per marcare Lockwood	3
portaghi tagliente Gillies	94	Cottle	129	strumento per marcare McKissock	4
Portaghi Webster	91	Schink Dermatomo	5	strumento per marcare Pitanguy	3
POTTS SMITH pinze anatomiche	36	SCHMEDEN pinza nasale tagliente	121	Strumento per marcare, Freemann	4
POTTS-SMITH pinza 1 x 2 denti	36	sega nasale angolata Joseph	139	T	
Providence-Hospital pinze emostatiche	61	sega nasale Joseph	138	TAKAHASHI pinza nasale tagliente	121
Q		SEMKEN pinze 1x2 denti	43	TAYLOR pinza a baionetta	44
QUISLING martello intranasale	100	SEMKEN pinze anatomiche	43	TAYLOR pinza anatomica	44
R		Separatori mammari Agris-Dingman	82	TAYLOR pinza chirurgica 1x2	44
RAGNEL divaricatore doppio	65	Separatori mammari MacCollum-Dingmann	83	Tebbetts divaricatori	78
RAMUS divaricatore	148	Separatori mammari Silverstein	83	TEBBETTS Separatori mammari	83
raspa nasal Dingman	138	Separatori mammari Tebbetts	83	Telaio solo per DAVIS BOYLE	142
raspa nasale Aufricht	135	Sgorbia Freer	132	Telaio solo per DAVIS MEYER	144
raspa nasale doppia Fomon	136	Sgorbia Hajek	132	Telaio solo per DINGMANN	143
raspa nasale doppia Fomon	137	Sgorbia Killian	130	Telaio solo per Kilner-Doughty	143
Raspa nasale Glabella	134	Sgorbia Killian-Claus	132	Tessier divaricatore	150
raspa nasale Joseph Lewis	135	Sgorbia nasale West	132	TESSIER Osteotomo	151
raspa nasale Maltz	134	Sgorbia periostotomo Boies	102	TieCK HALLE specoli nasali	112
raspa nasale Maltz (Cottle)	135	Silver dermatomo	6	Tritacartilagine Cottle	133
Raspa nasale Parkes	134	SILVER osteotomo nasale	130	Tritacartilagine Jost	133
Raspa nasale Peet	134	SILVERSTEIN separatori mammari	83	Troeltsch pinze auricolari	57
raspa nasale Wiener	134	SINGLEY pinze per tessuti	45	TYRELL uncinetto acuto	69
MT-BRAUN INSTRUMENTE coltello falcato	125	Sinus elevatore per setto	103	U	
REES elevatore per setto nasale	128	Spatola	80	Uncinetto acuto Frazier	70
Regolo metal.grad.mm/pollici	2	Spatole addominali Ribbon	66	Uncinetto acuto Graefe	69
Retrattore nasale Freer	88	Spazzolino	138	uncinetto acuto per pelle Kleinert-Kutz	70
Retrattore nasale Kilner	88	Specoli nasali	112	Uncinetto acuto Tyrell	69
Retrattore nasale Maliniac	87	Specoli nasali Cottle	115	Uncinetto doppio acuto Guthrie	69
Retrattore nasale Masing-Neivert	87	Specoli nasali Cottle	116	Uncinetto doppio per pelle Humby	71
Retrattori nasali Aufricht	87	Specoli nasali Hartmann	111	Uncinetto doppio smusso Guthrie	69
Retrattori nasali Converse	87	Specoli nasali Hartmann-Halle	110	Uncinetto per pelle Barsky	71
Retrattori nasali Cottle	87	Specoli nasali Killian	113	Uncinetto smusso Frazier	70
Retrattori nasali Cottle	88	Specoli nasali Killian	114	Uncinetto smusso Graefe	69
Retrattori nasali Fomon	88	Specoli nasali Tieck-Halle	112	Uncini per dura-madre Adson	85
Retrattore nasale Cottle-Neivert	88	Specoli nasali, mod. Wien	112	Uncini per nervi Crile	85
REYNOLDS forbici per dissezione	19	SPENCER forbici taglia fili	28	Uncini per nervi Cushing	85
RIBBON spatole addominali	66	SPINA-NASALIS divaricatore	148	Uncini per nervi destra e sinistra	77
ROCHESTER OCHSNER		STEVENS forbici delicate	24	Uncini per pelle Anderson	79
pinze emostatiche	63	STILLE pinza chirurgica	37	Uncino mucosa Joseph	70
ROCHESTER PEAN pinze emostatiche	63	STILLE pinze anatomiche	36		
Rollet divaricatore	86				
ROUX mini divaricat.doppio	65				

V	
VOLKMANN divaricatori	73
W	
Wagner forbici delicate	25
WALSHAM pinza per raddrizzare il setto nasale	140
Watson dermatomo	6
WAUGH pinze chirurgiche	41
WEBSTER portaghi	91
WEIL BLAKESLEY pinza tagliante nasale	120
WEITLANER divaricatori	76
WEST osteotomo nasale	132
WEST sgorbia nasale	132
WESTMACOTT pinza per medicature	117
WIEDER abbassalingua	141
Wiener divaricatori	86
WIENER raspa nasale	134
Wilde (Troeltsch) pinza auricolare	57
WILLIGER dissettori	101
Y	
YANCOSKIE divaricatori	79

Weitere Kataloge und Prospekte
Other cataloges and prospects

Arthroskopie
Arthroscopy

Container Steriltechnik
Container Sterilization Technique

Endoskopie
Endoscopy

HERCULES Drahtkneifzange
HERCULES Wire Cutters

Neurochirurgie
Neuro Surgery

Orthopädie
Orthopedic

Titan Instrumente
Titanium Instruments



MT- Braun Instrumente

Marktplatz 21, 78549
Spaichingen (Tuttlingen)

